

Contact Us: *FACTORY UTV LLC*

9237 Beatty Drive Sacramento, CA 95826

Phone : (916) 383-2730

E-mail : info@factoryutv.net

Go online: www.Factoryutv.net



U.H.M.W. Skid Plate / Under Armor Package

Ultra. High. Molecular. Weight. polyethylene all terrain skid plate / under armor kit for UTV's

Installation Guide (Ultimate Package)

Polaris RZR 4 800 (2010 - 2014)

Fits: RZR 4 800, EPS, LE, models



Polaris RZR 4 800 (2010 - 2014) Instructions

Remove stock skid plate and save center crossmember.

You will need to Re-use 14 stock bolts and washers, Skid's will form to vehicle during installation.

#1

UHMW Spacers :

*Install: Rectangular UHMW Spacers using : (A) bolts, without washers in (S:2, S:3, S:4) locations.
(during skid install, you will need to back these bolts out and re-install them with a countersunk washer, keeping spacers in place)*

#2_{a-b}

Main Skid (A & B) :

*Install using (A) bolts depending on your year model, in Main Skid : (A) locations.
Install main skid (I_a), before main skid (I_b). Slip (S:1) spacer in place with bolt during install.*

Once both skids are in place, back (S:4) bolts out and re-install bolts with crossmember and washers.

****(See Drilling Instructions Below)* Mark, drill and install (12x) ¼"-20 x 1" Self Tapping Bolts in Main Skid : (B) locations.***

Do not overtighten self tapping bolts.

****(S:4) Spacer & Crossmember Assembly***

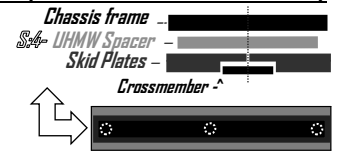

RS

If Rock Sliders RS (B*) :

****(See Drilling Instructions Below)* Use: (12x) ¼"-20 x 1 ¼" Self Tapping Bolts
Along main skid : (B*) locations, In lieu of (12x) ¼"-20 x 1" Self Tapping "(B)" bolts.
Place Rock Sliders in-between skid and chassis Frame after main skid is mounted,
Do not over tighten self tapping bolts.***



#3

Front and Rear Diff. Skid Plates :

****(See Drilling Instructions Below)* Align edge with Main Skid.***

Mark, drill and install: (4x) ¼"-20 x ¾" Self Tapping Bolts in each, front and rear diff. Skid : (C) locations.

F-R

Front A-Arm Guards (F)

Install : (4x) 1"x 1"- "D" clamps over A-Arm tubing W/ (4x) ¼"-20 x 1" Counter Sunk Bolts, (4x) ¼" Gold Washers, and (4x) ¼"-20 Ny-Lock Nuts in: (F) locations (On Each Front A-arm Guard).



Rear A-Arm Guards (R)

***Install : (4x) ¼"-20 x 2 ¼" Counter Sunk Bolts, W/ (4x) ¼" Gold Washers, and (4x) ¼"-20 Ny-Lock Nuts in: (R) locations.
(On Each Rear A-arm Guard)***

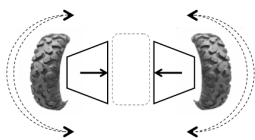

**** Ensure Clearance For Turn Radius & Vertical Travel
Before Fastening ALL Bolts Securely***

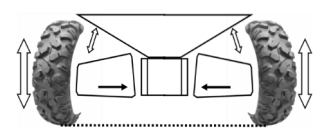

**** Drilling Instructions : ****

Use a : #Nº7 (13/64th) drill bit,

(one size above the commonly available 3/16th bit) Recommended ¼"- 20 Tap *(Optional)

To drill and thread self tapping bolts in to chassis frame.

Finger Thread All Bolts Prior To Fastening Securely With Power Tools.

***We strongly recommend the use of a "Thread Locking Compound" when installing any mounting hardware.
(When installation is complete , ensure all bolts are fastened securely.)***

Polaris RZR 4 800 (2010 - 2014)

Remove stock skid plate, Re-use Stock Washers as needed.
Skid plate will form to fit, See drilling instructions prior to drilling.

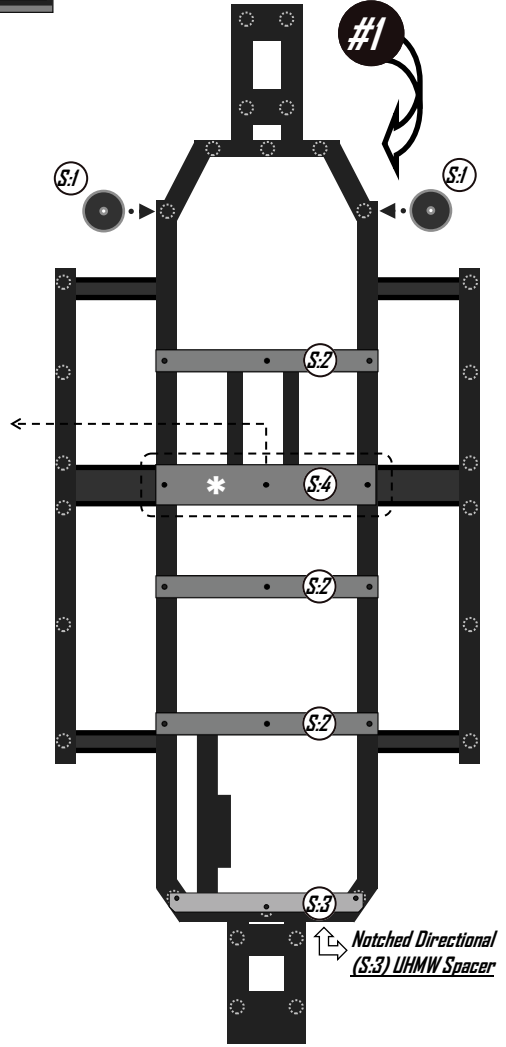
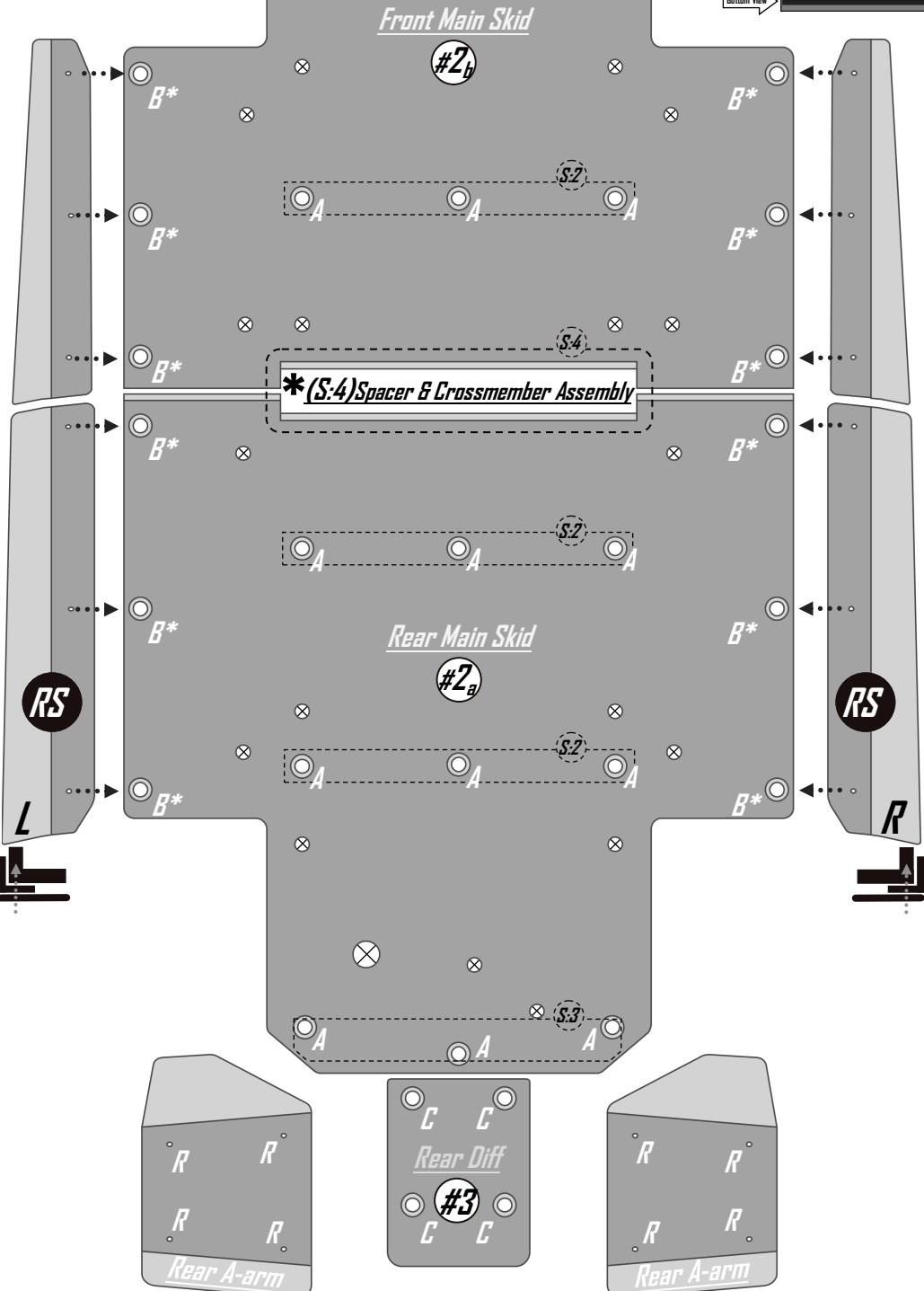
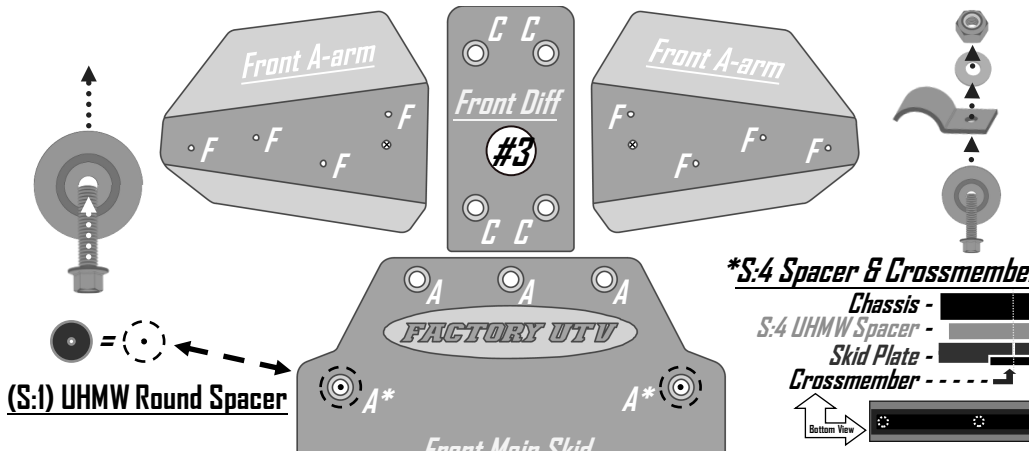

⊗ = Drainage Holes
 Do Not Use For Mounting

Polaris RZR 4 800 (2010 - 2014) Hardware kit

#1 Front & Rear Diff. Small bag :

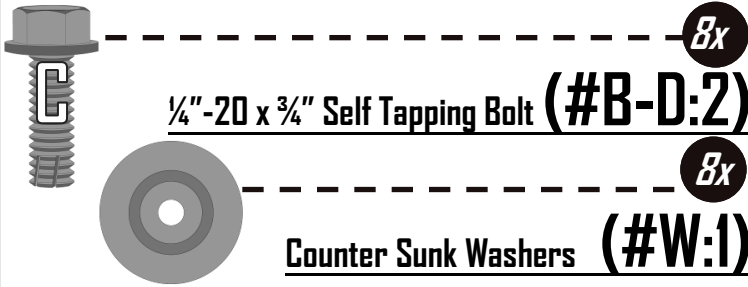

-12 Main Skid Large bag: 2011-2012 models

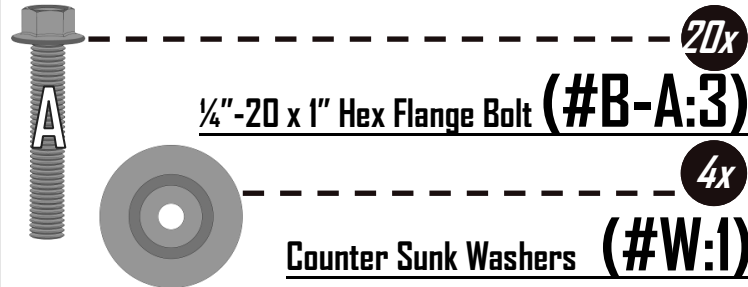

13+ Main Skid Large bag: 2013+ models

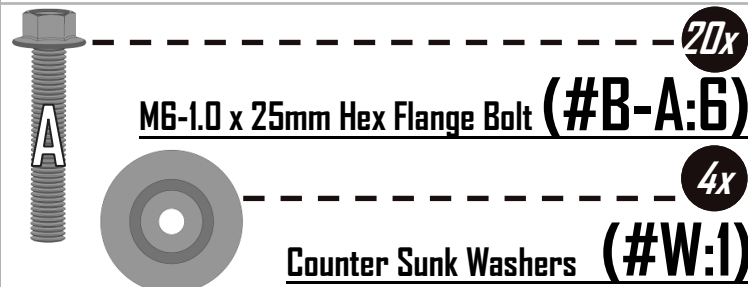

#3 Side bolts. Small bag :

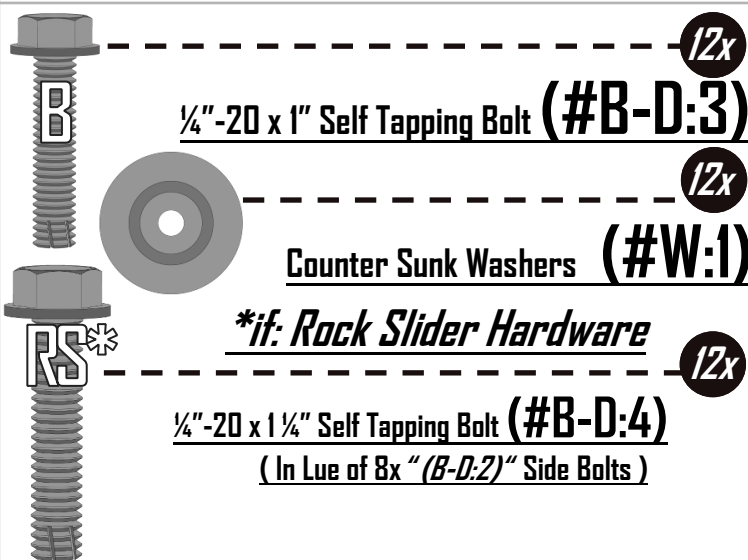

#4 Front A-Arm Guard small bag :

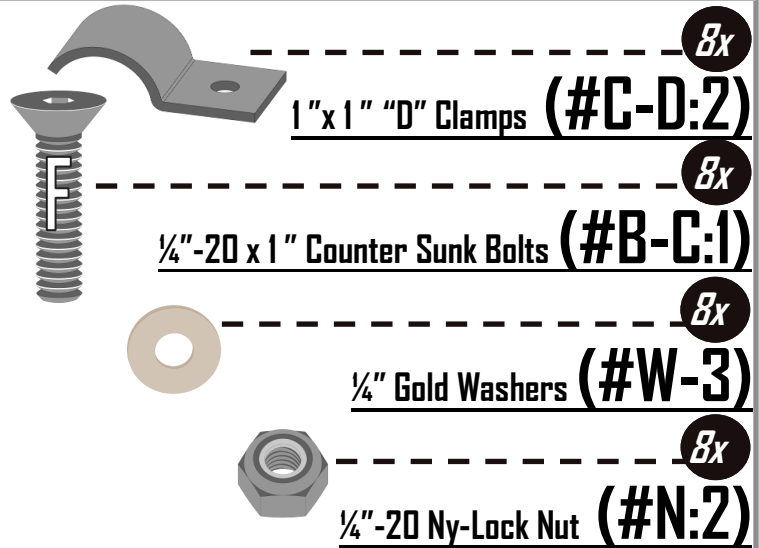

#5 Rear A-Arm Guard Small bag :

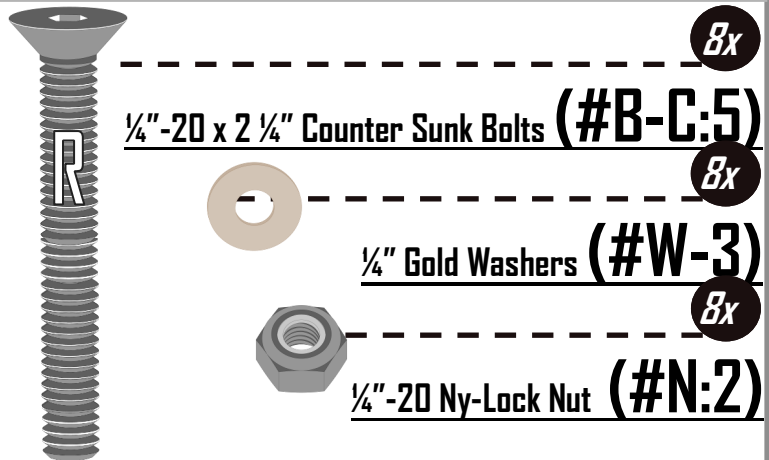

(Spacers banded to skid)

