

## TRACTION CONTROL SYSTEM (TCS) INSTALLATION 15-069 K-TCS 2 SWITCH GENERAL TREX TITAN

SVI, LLC 22JAN24

PART #: 15-069 K-TCS 2 SWITCH

DESCRIPTION: TRACTION CONTROL SYSTEM 2 SWITCH GENERAL, TREX, TITAN

FITS: MY17-24 GENERAL ALL MODELS; RANGER FULLSIZE ALL MODELS THRU MY19, BOBCAT and GRAVELY ALL MODELS THRU MY18,

THIS INCLUDES ALL GENERAL MODELS WITH LOCKING REAR DIFFERENTIAL, T-REX AND TITAN CHASSIS MODELS, NOT ZEUS OR HERCULES CHASSIS MODELS

EXCEPT MY16 GENERAL; MY18,19 RANGER 1000XP (ZEUS)

### KIT CONTENTS

- 1 38-037 HARNESS-TCS 2 SWITCH UNIVERSAL WITH 38-022 (10 PIN VC-1) CONNECTOR INSTALLED
- 2 38-005 FRONT DRIVE SWITCH
- 3 38-006 REAR DIFLOC SWITCH
- 4 38-035 RELAY-REAR DIFFERENTIAL TROMBETTA
- 5 97-022 REAR DIFLOC DECAL DASH
- 6 95-079 Qty 2 CABLE TIE 14" BLACK
- 7 99-025 Qty12 CABLE TIE 8" BLACK 7080138
- 8 98-054 OWNERS MANUAL SUPPLEMENT
- 9 98-117 INSTALLATION INSTRUCTIONS (THESE INSTRUCTIONS)

GENERAL INSTALLATION – SEE RANGER INSTALLATION AFTER GENERAL

Go to our YouTube channel to watch installation video

<https://www.youtube.com/user/SpecialtyVehiclesInt/videos>

1. Start by removing the Driver's seat, if a 4 seat remove rear driver side seat. Lift up rear cargo box.
2. Remove stock relay from frame located on the rear driver side, on inside of frame, unplug top connection.



3. Connect new 38-035 relay that comes with kit onto the TCS wiring harness.



4. Install new relay onto the frame using 14" zip ties, plug top connection of vehicle harness unplugged in step 2 into TCS harness.



5. Run TCS harness on inside of frame down to clutch cover area. Unplug the stock relay and remove, plug TCS harness into that connection. Leave TCS harness loose for now, entire harness will be cable tied at the end.



6. Disconnect the switch end of TCS harness for ease of routing main harness thru the vehicle.



7. Route TCS harness following ducting of the clutch to two vent central tubes in middle of machine then forward to front of vehicle. Pull push rivets to gain access to center console area to pull harness thru. There is a plier in vehicle tool kit that has a groove in it to assist push rivet removal.





8. Remove center dash to assist in pulling TCS harness thru. Route harness thru dash, then up and around steering column over to switch area on left side of steering wheel. Take care not to interfere with any moving or steering components.



9. Cut hole into dash for the rear difloc switch using provided template at end of instructions. Double check that cutout dimensions match paper cutout and nothing is behind the area that is being cut. Once hole is cut, feed harness out of cut hole and attach switch end removed in step 6. Connect Rear Difloc switch to switch block on harness making sure that pins on back of switch mate with metal connections on switch block and push switch into cut hole.



10. Remove the stock drive mode switch to left of rear difloc switch. Replace with Front Drive switch provided with kit. Stock harness behind dash may be tight so hold onto switch block behind dash to assist in connecting switch.



11. Turn the key to on position, do not start. Push Front Drive switch to on position, switch will be lit yellow. Always leave this switch in the on position. Now push Rear Difloc switch to on position, you should hear a clicking noise come from the rear differential, when you hear the noise you know that it is working, turn key off. The switch will blink red when on. Only turn Rear Difloc on when needed such as going over a log or thru some mud or snow, then turn off.
12. Now that everything is working correctly, secure TCS harness from front to back and using provided cable ties and secure harness away from moving parts and places that could cut wires.

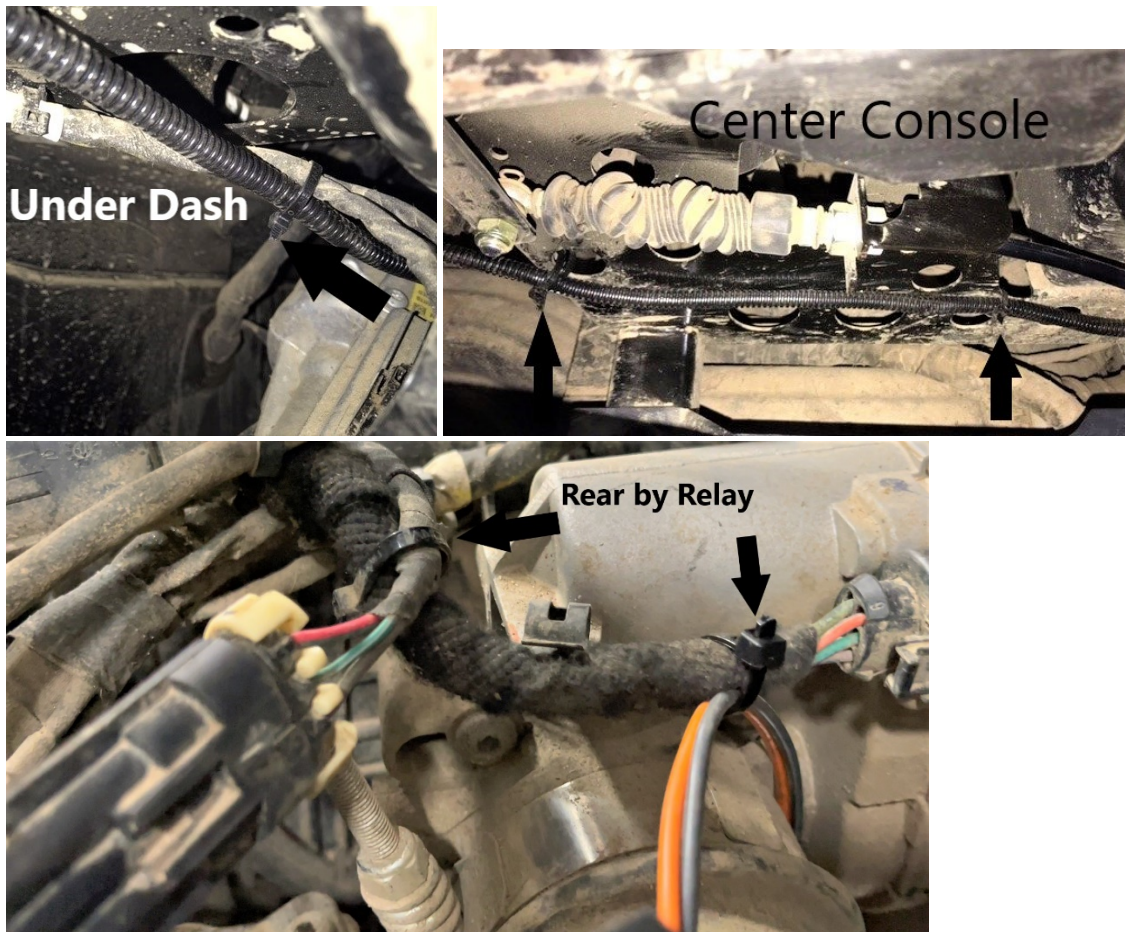

13. Install dash decal provided with kit, this gives a brief tutorial of the switch usage.

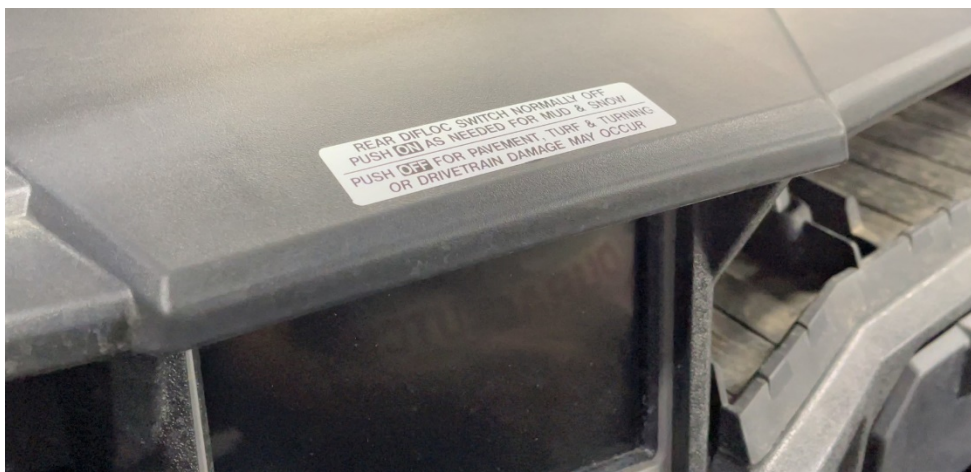

For more information on operating see Owner's Manual Supplement included with kit.

## Switch cut out template

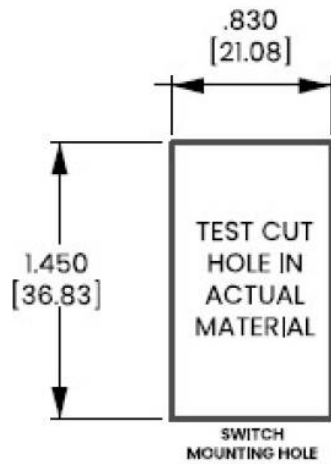
RANGER Titan chassis, MY18 & older BOBCAT and GRAVELY INSTALL INSTRUCTIONS

Note: Diagrams shown are of the RANGER. BOBCAT and GRAVELY are similar.  
The text is above the picture it refers to.

1. Remove upper dash panel - plastic push rivets. These parts will be reinstalled. Use plier in tool kit with notched jaws for removing push rivets.

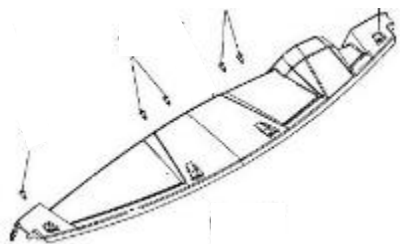

2. Remove drive shaft cover(s) - plastic push rivets - on floor(s) in front of seat. These parts will be re-installed.

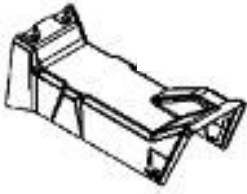

3. Remove the seat in front of the rear box. Remove tub from under driver's side.
4. Remove the relay at the rear of vehicle under the box. The relay is mounted on the frame behind the differential (10mm head bolt and nut). The relay and bolt/nut will not be re-used. Unplug the 2 relay connectors from the vehicle harness.

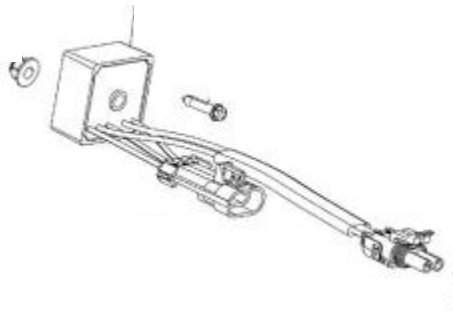

5. The 38-035 REAR DIFFERENTIAL RELAY is installed in place of the removed relay. Plug the TCS HARNESS square connector into the REAR DIFFERENTIAL RELAY as shown.

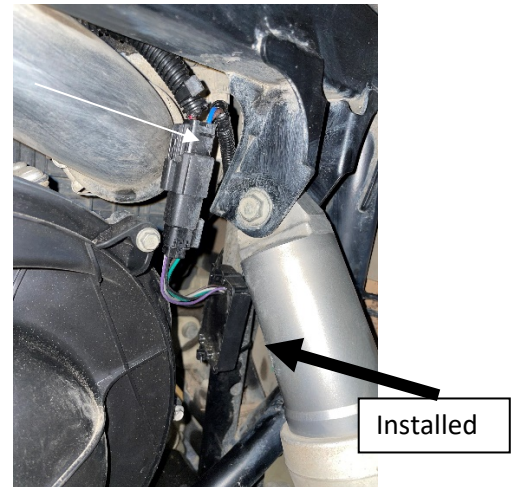
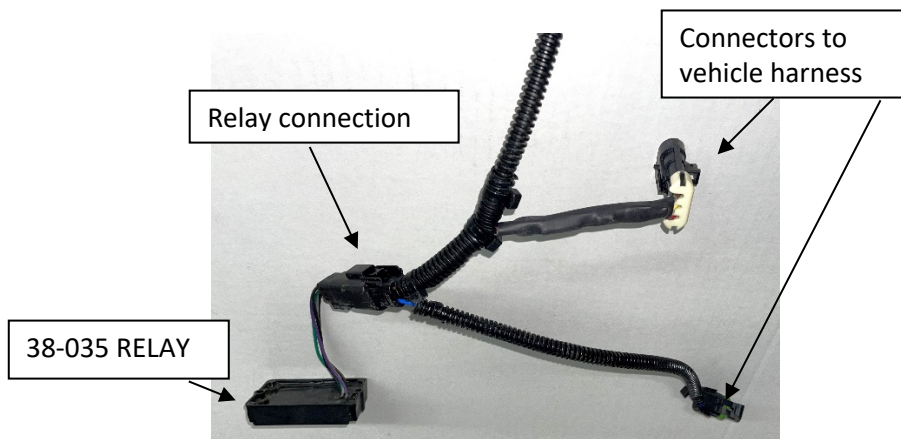

6. Mount the relay as follows:
  - a. On the front side of the rear chassis frame behind the differential.
  - b. Place the relay with the square connector facing down and close enough to reach the 2 vehicle harness connectors unplugged from the removed relay.
  - c. Mount to the frame with the 14" zip ties.
  - d. Connect the relay to the 2 vehicle harness connectors.

NOTE: Mounting area may look slightly different depending on model. Locate the relay on the Bobcat, Gravelly and later RANGER chassis (Zeus) as required.



7. Proceed with the next routing steps. Disconnect the switch end of the TCS for ease of routing main harness thru the vehicle.



8. The pictures show routing in the RANGER Titan chassis. Other chassis are similar. Route from the rear to the front leaving the wire ties loose. When all are in place tighten the wire ties from rear to front.
- The harness should be routed so that it does not touch the engine and does not interfere with clutch housing removal.
  - Take care not to tie against sharp edges.
  - Route through fuel tank area. Tuck and tie as shown.

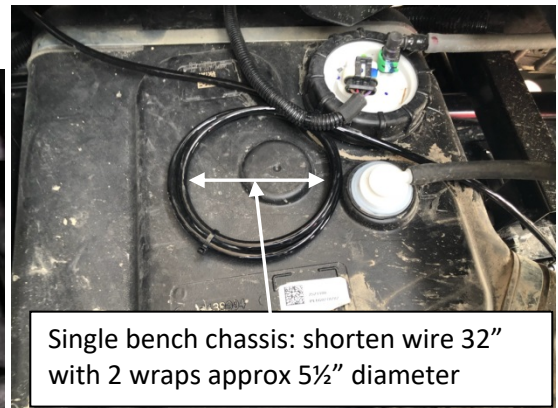
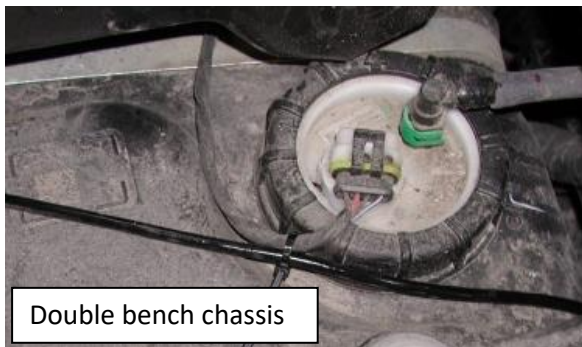

- Route through existing clips under driveshaft for cover(s).

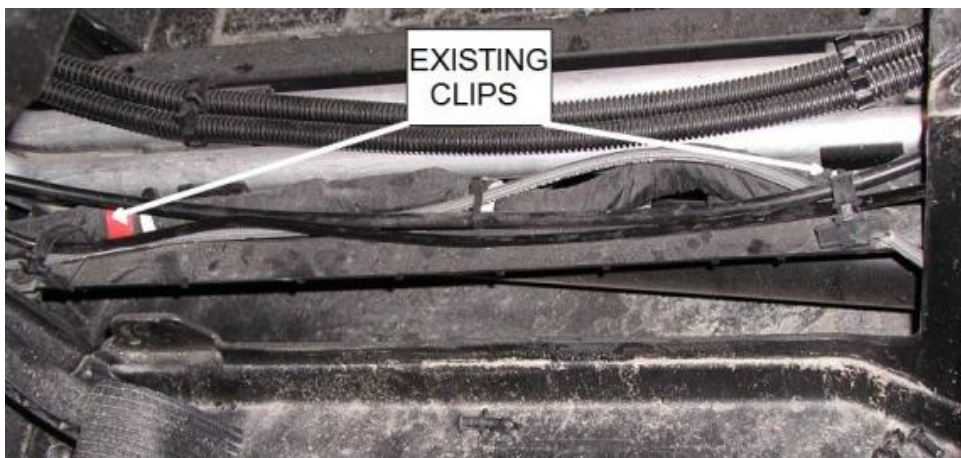

- E. Route through the front up to the dash panel, avoid the steering u-joint (orange illustrates routing).



- F. Pull the harness snug in the dash area and tie similar as shown. Pull snug before tightening this final tie to help keep the harness away from the steering u-joint.



9. Switch Installation: The 38-005 FRONT DRIVE SWITCH replaces the AWD switch. The 38-006 REAR DIFLOC SWITCH is added on the dash.  
If there are not enough slots in the top dash switch line-up to add the REAR DIFLOC SWITCH, use a utility knife to carefully cut a hole in the lower dash panel just large enough to seat the switch. Note the back-of-panel shadows to use for guides. Remove the two bottom screws from the dash panel for easier access.



Note: The lower dash area is used for the cab heater control if a heater is installed. If more room is needed in the upper dash, you can remove the winch switch and substitute the Polaris Accessory Winch Power Controller on the shift handle, the Polaris Accessory Wireless Winch Remote, or the Polaris plug-in winch control, to operate the winch.

10. Connect to the REAR DIFLOC SWITCH to the jumper harness detached in step 7.



11. Push switch jumper harness through the REAR DIFLOC SWITCH dash hole and seat the switch. Plug the jumper harness into the TCS HARNESS.
12. Unplug the connector from the AWD switch and remove the AWD switch from the dash. Replace with the FRONT DRIVE SWITCH. Plug the AWD connector into the FRONT DRIVE SWITCH.



13. The switch and harness installation is complete. Turn the key on (engine off) and place the gear shift in HI, LO or REV. Cycle the REAR DIFLOC switch on and off and verify an audible “click” from the rear solenoid.
14. Reassemble parts removed in steps 1, 2 & 3.

15. Apply the operation decal REAR DIFLOC DECAL DASH, in a visible place as shown in the photos. Clean surface with alcohol or other non-residue, non-caustic cleaner. Use decal squeegee or fingers to work out any air bubbles.

RANGER Titan dash



Gravelly Atlas dash



REAR DIFLOC decal.