



# LIT-C65U

SWITCH Works RGB Cage Pod with  
Rocker Switch Controller  
and Clamp Pack



## RGB LED CONTROLLER COMMAND CENTER

### FEATURES:

- 4 Modes: Solid Color, Slow Pulse, Strobe, and Color Change
- Adjustable Color, Speed and Brightness Function
- Backlit Buttons
- Input Voltage: 12vdc
- Weather-Proof Controller
- Fits Standard Rocker Switch Cutouts
- Dual Programmable Favorites Button
- 3 Outputs with a Total of 15 amps
- Isolated Control for Output 1



# PARTS LIST



Unloaded RGB Cage Pod Pair



230-LIT-CC RGB Rocker Switch Controller



1.75" Clamp Pair



1.85" Clamp Pair



2.00" Clamp Pair



Dual Clamp Base (x2)



M6x20 Bolt and Washer Pack (x1)



M6x45 Socket Head Cap and Washer Pack (x2)



#7x1.25" Screw Pack (x1)



M6x6 Set Screw Pack (x2)



RGB Extension Harness, 8 ft (B-H2933)



Universal RGB Cage Pod Pig-Tail, Pair (B-H3083)



RGB/Rear Speaker Harness, 7 ft (B-H2936)



4-Pin Audio Extension Harness, 2 ft (B-H1912)



4-Pin Audio Extension Harness, 8 ft (B-H1913)



RGB Extension Harness, 2 ft (B-H2934)



10" Zip Tie, 5 Pack (B0-WP-ZT10-5)

# WIRING DIAGRAM OF COMPLETE KIT

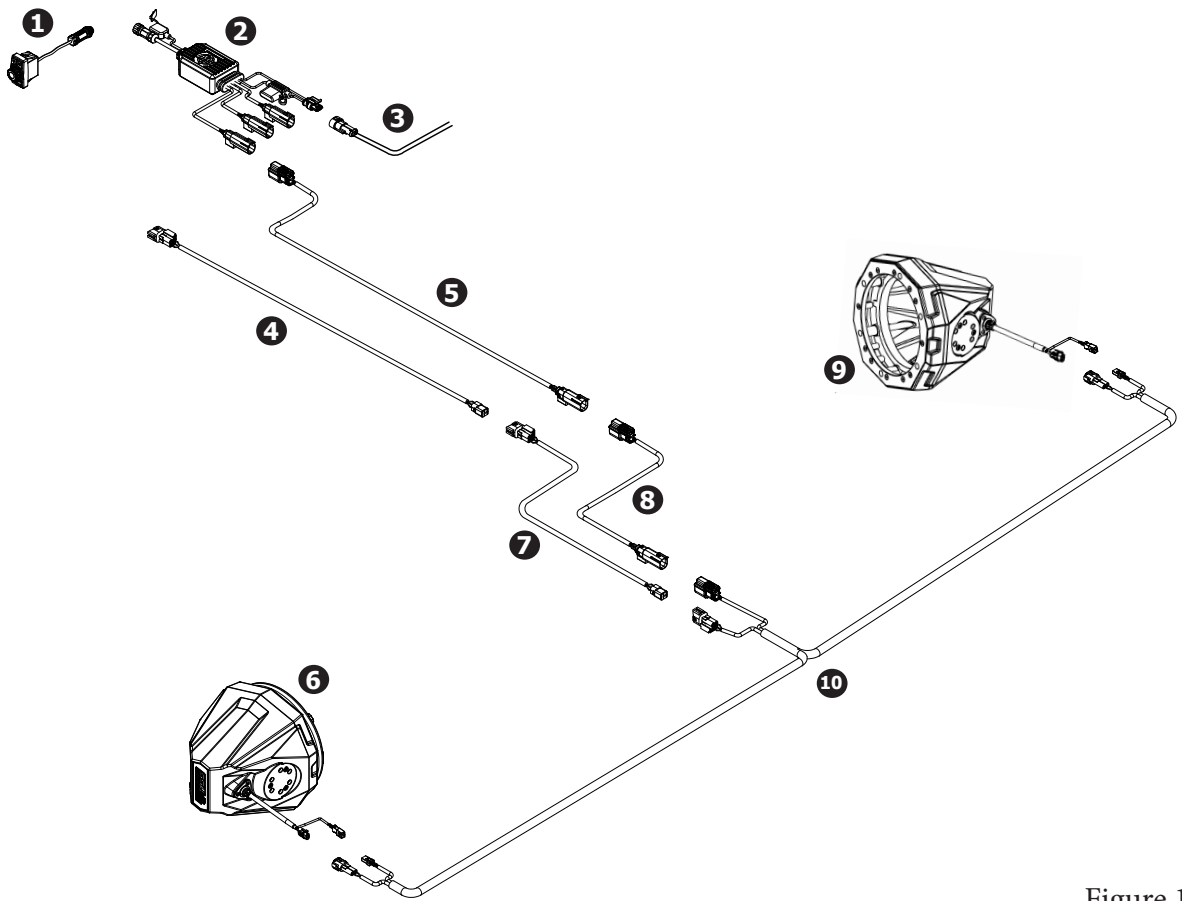

Figure 1

Figure 1 is designed to show the installer a reference overview of the cage pod speaker RGB LED wiring diagram. Each installation section will have its own detailed wiring diagram.

	Description	Part #
1	RGB LED Controller Rocker Switch for 230-LIT-CC	230-LIT-CC
2	SWITCH Works RGB LED Controller Command Center	
3	230-LIT-CC Power Harness	
4	4-Pin Audio Extension Harness, 8 ft.	B-H1913
5	RGB Extension, 8 ft.	B-H2933
6	RGB, 6.5" Unloaded RGB LED Cage Pod, Left	B-USL-C65
7	4-Pin Audio Extension Harness, 2 ft.	B-H1912
8	RGB Extension, 2 ft.	B-H2934
9	6.5" Loaded RGB LED Cage Pod, Right	B-USL-C65
10	RGB Rear Speaker Harness, 7 ft.	B-H2936



# RGB LED CONTROLLER COMMAND CENTER PARTS LIST

## WARRANTY INFORMATION:

All SSV Works enclosures are covered by a limited lifetime warranty against defects in material or workmanship. All SSV Works Electronics are covered by a limited 1 year warranty against defects in material or workmanship. Labor for replacement of defective components is not covered. Contact SSV Works for further warranty information.

## PARTS LIST IMAGES



1. LIT-CC, 3 Output, RGB LED Controller Command Center



2. LIT-CC RGB LED Controller Rocker Switch

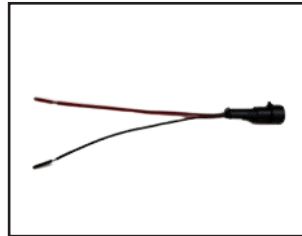

3. Power Pigtail

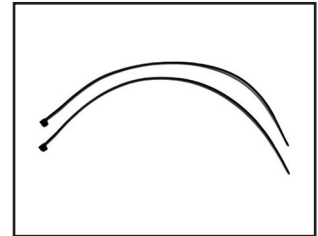

4. Zip Ties (x2)

## NOTE:

Included Universal Controller Pigtails are NOT used in this installation.

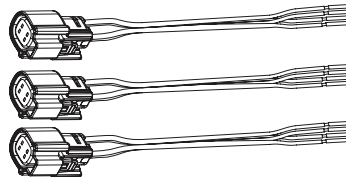

# RGB LED CONTROLLER COMMAND CENTER INSTALLATION

## TOOLS NEEDED FOR INSTALLATION

- Wire Cutter

- Wire Stripper

- Crimper

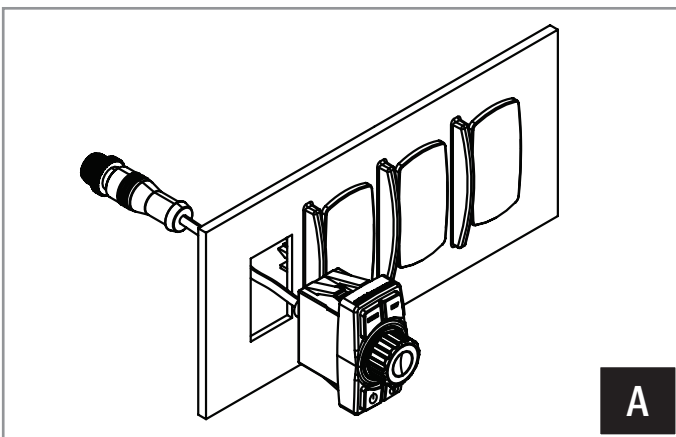

A

A. Install the LIT-CC RGB LED Controller Rocker Switch in an unoccupied rocker switch opening.

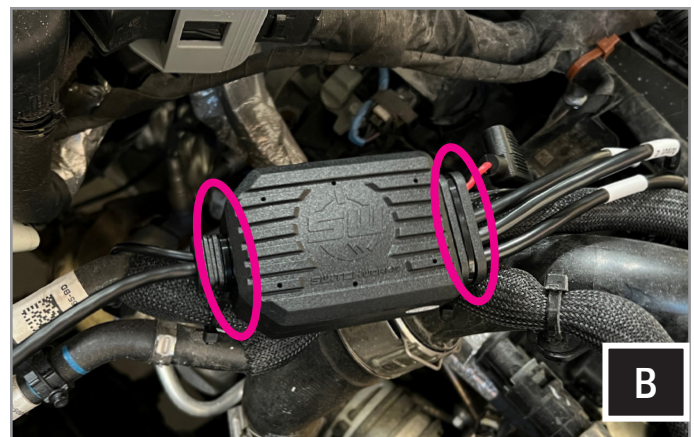

B

B. Mount the LIT-CC RGB LED Controller Command Center in the dash away from moving parts and secure with zip ties. Cut excess zip ties for a clean install.

**NOTE:** Refer to the 230-LIT-CC User Guide for detailed operation instructions.



# RGB LED CONTROLLER COMMAND CENTER WIRING DIAGRAM

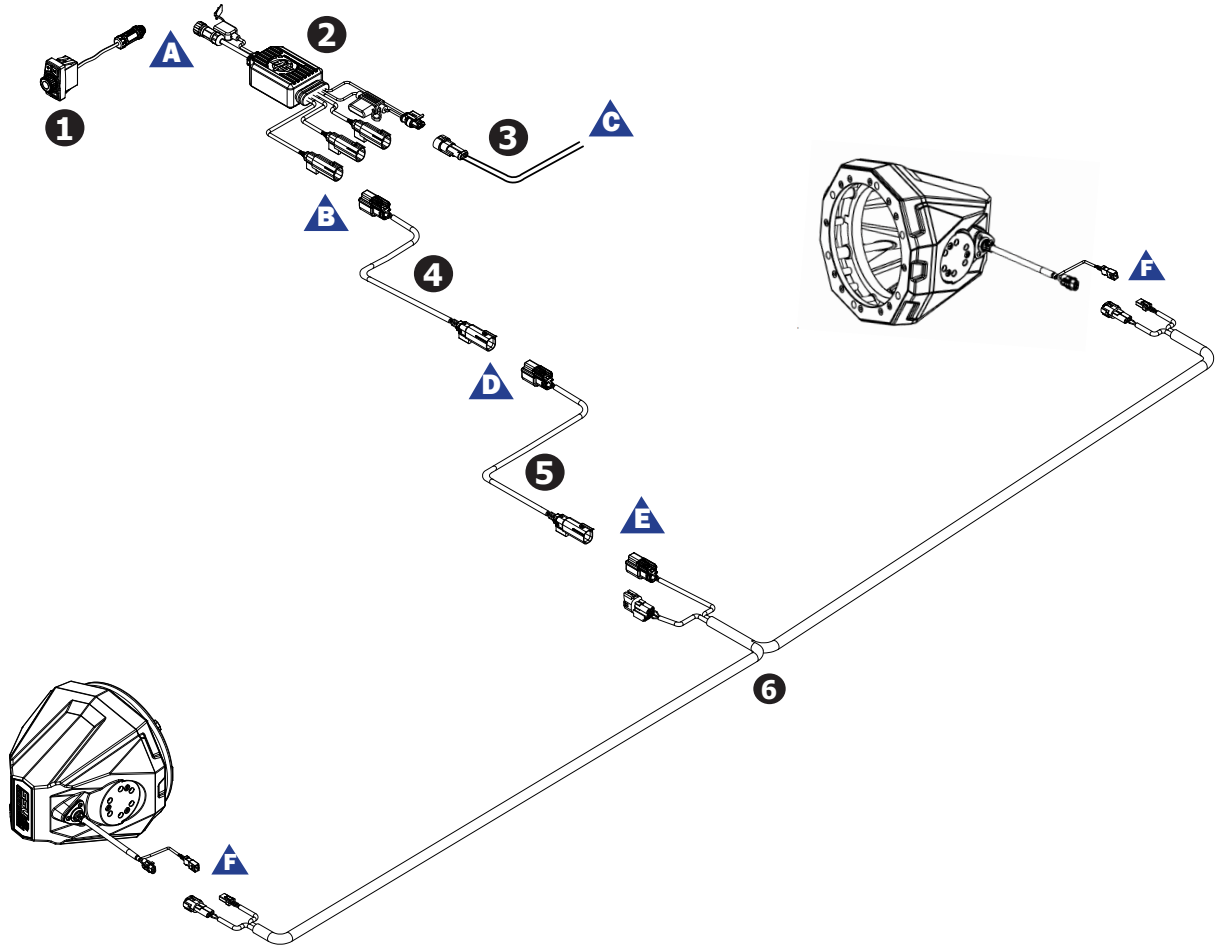

	Description	Part #
1	RGB LED Controller Rocker Switch for LIT-CC	230-LIT-CC
2	LIT-CC RGB LED Controller Command Center	
3	LIT-CC Power Harness	
4	RGB Extension, 8 ft.	B-H2933
5	RGB Extension, 2 ft.	B-H2934
6	RGB Rear Speaker Harness, 7 ft.	B-H2936

Detail	Description
A	Connect RGB LED Rocker Switch to LIT-CC
B	Connect Front Output to RGB Extension B-H2933
C	Connect LIT-CC Power Harness to Battery or ACC
D	Connect RGB Extension B-H2933 to B-H2934 (for 4 door models)
E	Connect RGB Extension B-H2934 to RGB Rear Speaker Harness
F	Connect RGB Rear Speaker Harness to Cage Pods

# REAR RGB LED CAGE POD PARTS LIST

## PARTS LIST IMAGES



B-LIT-C65 Unloaded Enclosures (1 pair)



B-H2195 Rear Speaker Harness



B-H1913 Speaker Extension Harness



B-H2933 RGB Extension, 8 ft.



4-Pin Extension Harness, 2 ft. (for 4 door models)



B-H2934 RGB Extension, 2 ft. (for 4 door models)



M6x1.0x45mm (5mm Allen Head) Screws & Washers x4



M6x1.0x6mm (3mm Allen Head) Screws x8



M6x1.0x20mm (8mm Hex Head) Screws & Washers x4



Zip Tie Panel Post x5



Zip Ties



Dual Clamp Base x2)



1.75" Clamp Pair



1.85" Clamp Pair



2.00" Clamp Pair

# REAR RGB LED CAGE POD INSTALLATION

## INSTALLATION NOTES

It is recommended to wrap the bag that the clamps come in around the cage before you slide the clamp onto the cage to prevent scratching.

Placement of the pod depends on what type of roll cage you have (factory or aftermarket) and your preference of where you want the pods to be installed. In these instructions, we have installed them on the outside vertical bars at the back of the roll cage.

## TOOLS NEEDED FOR INSTALLATION

- 5mm Allen Key

- 8mm Open End Wrench



A. Find the best orientation for the speaker on your bar and screw in the Set Screws in the OPPOSITE holes of where the clamp will install into.



B. Loosely install the clamp base to the cage mount pod with the two (2) M6 hex head bolts and washers, place the cage mount pod in the desired mounting location on the vehicle. Once the ring adapter is in the desired position, tighten the two (2) bolts using a 8mm open wrench.



C. Place both ring mounting clamps on the cage using the plastic bag to prevent scratching, place the cage mount pod in its final mounting location and secure to the clamps using the two (2) M6 allen socket head bolts and washers with a 5mm allen key.





D. Position the speaker to your liking and tighten the hex head bolts by hand with a 8mm wrench.



D. Take the B-H2195 rear speaker harness and plug into the B-H1913 & B-H1912 rear extension harness.



E. Route the rear speaker harness (B-H2936) along the factory wires in the engine compartment and pull up through the small space between the bed panel and cage tubing on both passenger and driver sides.



F. Install the speakers to the cage mount and route the speaker wire away from any moving parts and any sharp metal, then connect to the radio or amplifier.

# REAR RGB LED CAGE PODS WIRING DIAGRAM

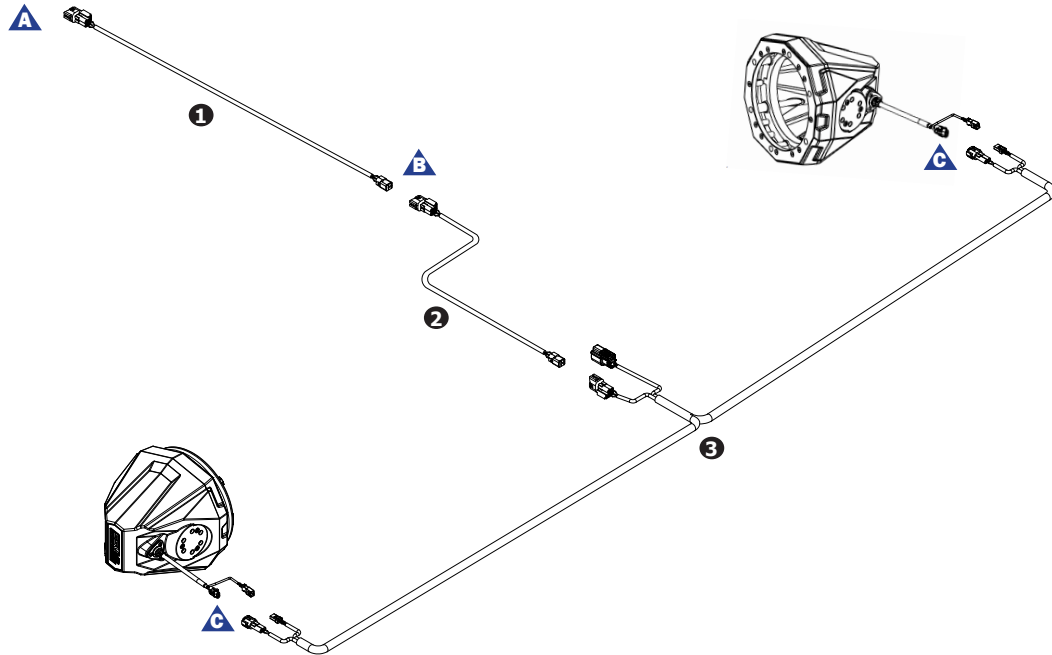

	Description	Part #
①	4-Pin Extension Harness, 8 ft.	B-H1913
②	4-Pin Extension Harness, 2 ft. (for 4 door models)	B-H1912
③	RGB Rear "Y" Speaker Harness, 7 ft.	B-H2936

Detail	Description
A	Connect B-H1913 4-Pin Ext. Harness, 8 ft. to radio or amplifier
B	Connect B-H2913 Audio Ext. Harness, 8 ft. to B-H2936 or add B-H1912 Audio Ext. Harness, 2 ft for 4 door models
C	Connect B-H2936 RGB Rear "Y" Harness to the Left and Right Cage Pods



**THANK YOU!**

We are committed to your satisfaction and we know you will enjoy our products. If you have questions or need any assistance, please let us know.



SSVWORKS.COM



1-818-991-1778 EXT 2



SUPPORT@SSVWORKS.COM

Returns must be made within 30 days of purchase date. Claims for missing items or items damaged in transit must be received within five business days of receipt of merchandise. All returns must be in original packaging and in re-sellable condition. Shipping fees are not refundable.