



SSV WORKS, 4610 Calle Quetzal, Camarillo, CA 93012  
www.SSVworks.com | Phone: 818-991-1778 | Fax: 866-293-6751

# RZ5-PHZ5VRC

2020-2024 Polaris RZR Pro  
Phase-5 V-Spec 1400 Watt 5 Speaker  
RGB Audio Kit for Ride Command



RZR Pro XP

pg **3**  
Door Panel  
Disassembly



pg **7**  
Amplifier  
Installation

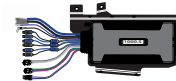

pg **9**  
Anti-Pop Circuit  
Installation



pg **11**  
LIT-CC RGB Controller  
Installation



pg **14**  
Subwoofer  
Installation



pg **18**  
RGB Dash Pod  
Installation



pg **22**  
RGB Rear Speaker Pod  
Installation



# WIRING DIAGRAM OF COMPLETE KIT

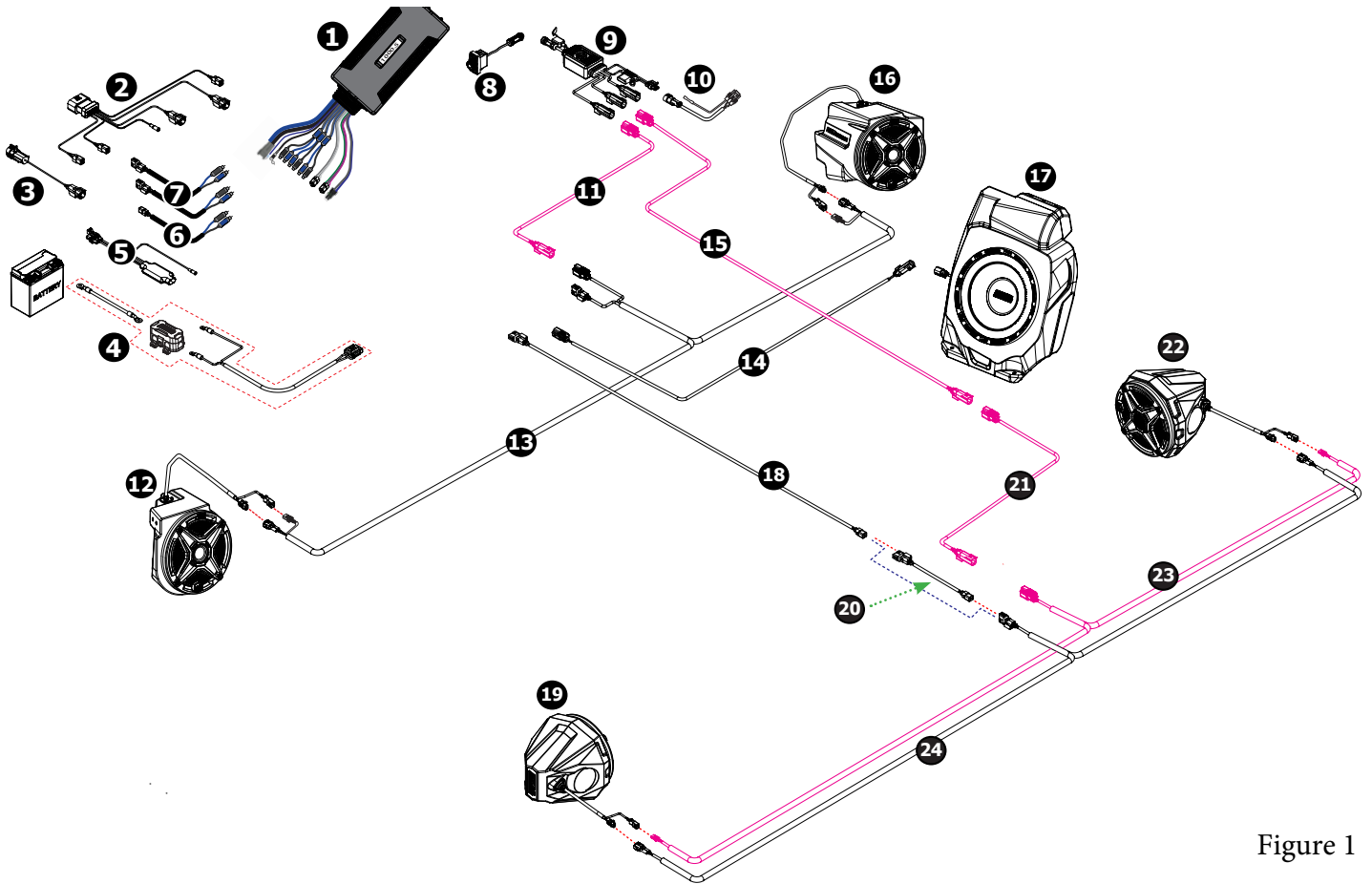

Figure 1

Figure 1 is designed to show the installer a reference overview of the complete 5 speaker RGB wiring diagram.

	Description	Part #		Description	Part #
1	Kicker PXA1000.5 Amplifier	SD-PXA10005	13	Driver/Passenger RGB/Audio "Y" Speaker Harness	B-H2935
2	RZ5 Factory Harness Amplifier Bypass Harness	B-H2591	14	2-Pin Audio, Sub Extension Harness	B-H3074
3	RZ5 Subwoofer Adapter Harness	B-H2276	15	RGB Extension, 8 ft.	B-H2933
4	Amp Wiring Kit Assembly, 10 ft.	A-H1Q	16	Front Dash Pod Enclosure, Passenger Side	B-RZ5-PF65
5	RZ5 Amplifier Anti-POP Circuit	B-H2917	17	Loaded Under Dash Sub, 10" 2 ohms	230-RZ5-UD10V
6	4 Pin Female to 2 RCA Male Plug Harness, 6"	B-H3545	18	4-Pin Audio Extension Harness, 8 ft.	B-H1913
7	4 Pin Male to 2 RCA Male Plug Harness, 6" (x2)	B-H3543	19	6.5" Loaded Cage Pod, Driver	B-USL-C65
8	RGB LED Controller Rocker Switch for 230-LIT-CC	230-LIT-CC	20	4-Pin Audio Extension Harness, 2 ft.	B-H1912
9	SWITCH Works RGB LED Controller Command Center		21	RGB Extension, 2 ft.	B-H2934
10	230-LIT-CC Pulse Connector Power Harness	B-H2744	22	6.5" Loaded Cage Pod, Right	B-USL-C65
11	RGB Extension, 2 ft.	B-H2934	23	Rear RGB "Y" Harness, 7 ft.	B-H2936
12	Front Dash Pod Enclosure, Driver Side	B-RZ5-DF65	24	Rear "Y" Speaker Harness, 7 ft.	B-H2195

## PANELS AND DASH DISASSEMBLY



A. Remove all the seats from the vehicle. Compress the release lever located in front of the seat base. With the release lever compressed, tilt the seat forward and remove from the vehicle.

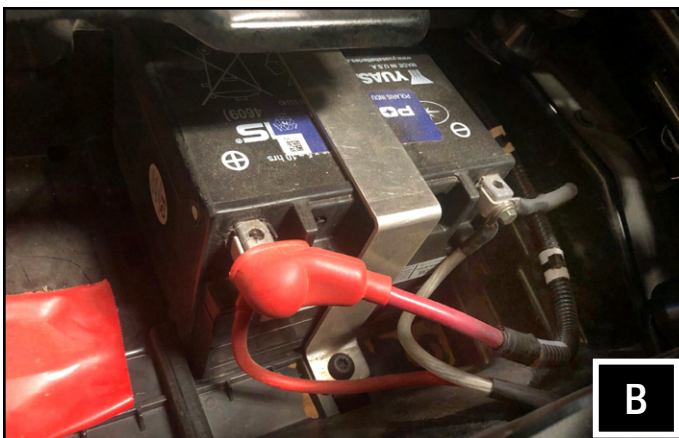

B. Using a 8mm wrench. Disconnect the negative battery cable from the battery.



C. Remove the (2) T40 torx screws and set the hood panel aside.

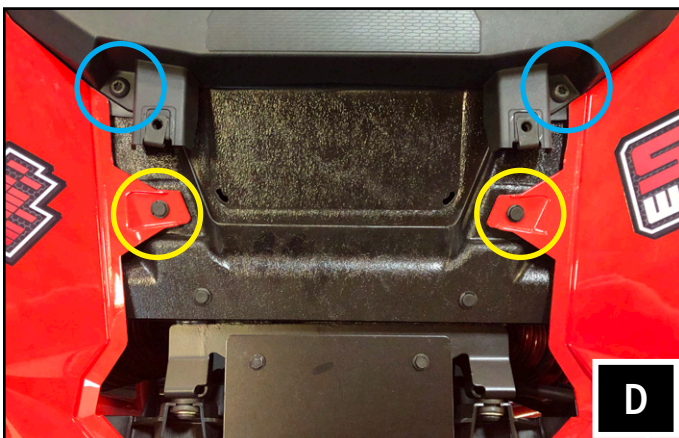

D. Remove the (2) T40 torx screws and (2) push pins with a panel removal tool.



E. Open the top-center dash compartment and lift to remove the compartment tray. We recommend using a panel tool to assist releasing the tray from the compartment. Once the tray is separated from the compartment, pull out the USB cable from the tray, set tray to the side.



F. Use a panel tool to assist with the removal of the (3) trim panels. The blue highlighted points represent the location of the panel clips that are retaining the trim panels to the dash.

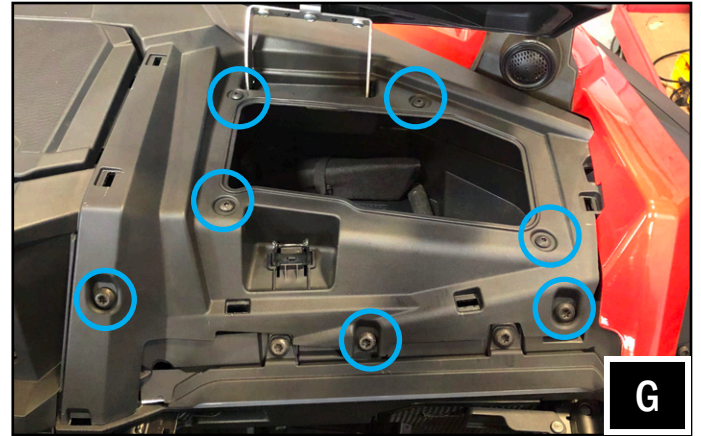

G. Open the glove compartment. Remove the (4) T25 Torx screws and (3) T40 Torx screws.

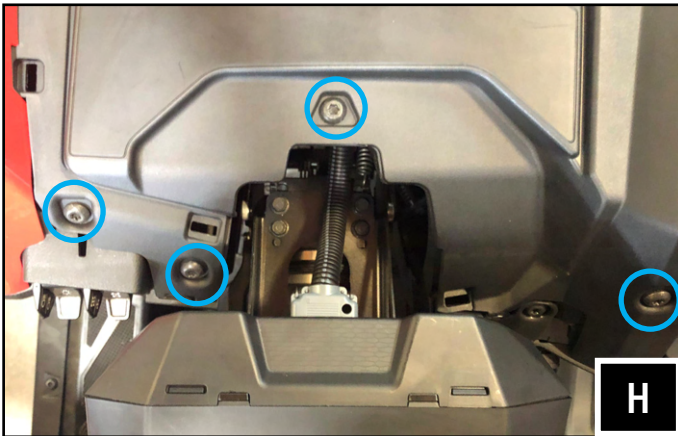

H. Remove the (4) T40 Torx screws that surround the gauge cluster. For ease of access to each screw we recommend adjusting the position of the steering column accordingly.



I. Use a panel to aid in lifting the fenders to release the top dash panel.



J. Pull dash from the vehicle.



K. Lift and remove the glove compartment from the dash cavity.

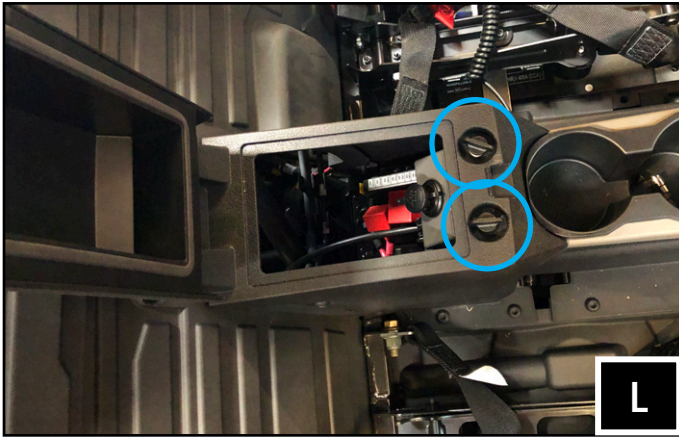

L. Open the center console and twist to disengage the locking pins and lift out the center console tray.

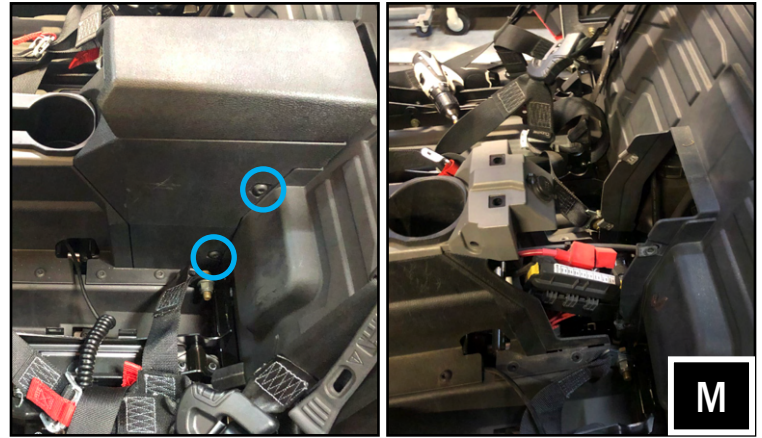

M. Remove the (2) T40 torx screws from both sides of the center console and lift out the rear portion of the center console.



N. Disconnect the 12V socket.

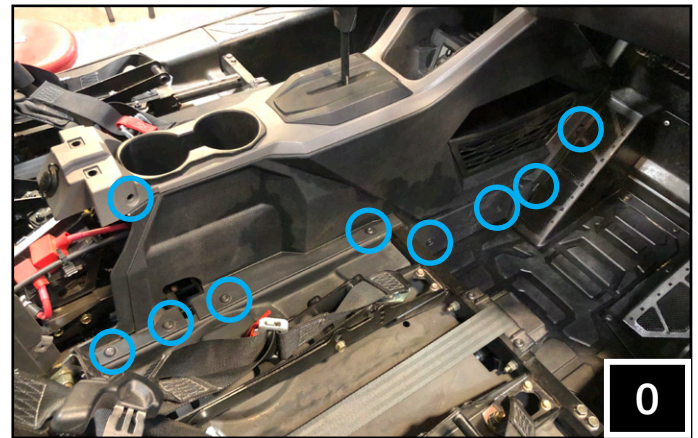

O. Remove the (1) push pin and (8) T40 screws from each side of the remainder of the center console.



P. Remove the (2) push pins that are found on the bottom of the dash towards the center console.

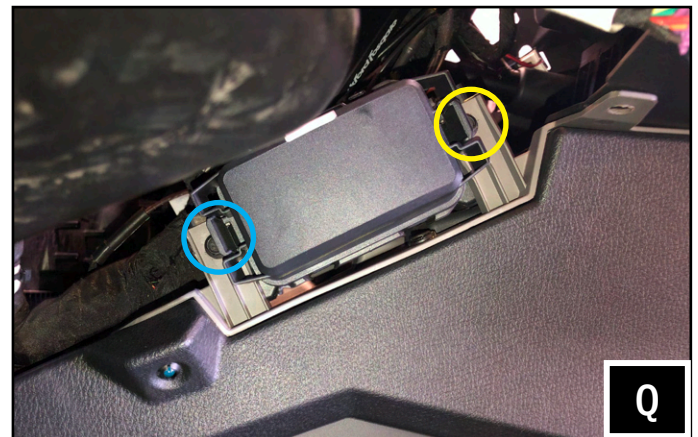

Q. Loosen the 10mm screw on the left of the fuse block (circled in blue) and remove the 10mm screw on the right (circled in yellow). The fuse block is located on the driver side of the center console near the gas pedal.



R. Rotate the fuse block counterclockwise and remove the now exposed push pin.



S. Remove the (2) push pins on the passenger side front of the center console.



T. Lift the shift boot to expose the (1) T40 screw for removal



U. Gently lift center console to release/separate driver and passenger console side panels



V. With the center console separated, unclip the LED from the driver and passenger console side panel. Once the LEDs have been unclipped, remove the driver console side panel from the vehicle.



W. Twist the lock knobs on the rear firewall and remove the firewall.

# AMP PLATE INSTALLATION PARTS LIST

## WARRANTY INFORMATION:

All SSV Works enclosures are covered by a limited lifetime warranty against defects in material or workmanship. All SSV Works Electronics are covered by a limited 1 year warranty against defects in material or workmanship. All SSV Works Speakers are covered by a limited 1 year warranty against defects in material or workmanship. Labor for replacement of defective components is not covered. Contact SSV Works for further warranty information.



Please read and understand these instructions completely before installation to avoid possible injury, or damage to the accessory or vehicle.

## TOOLS NEEDED FOR INSTALLATION

- 8mm Socket Wrench

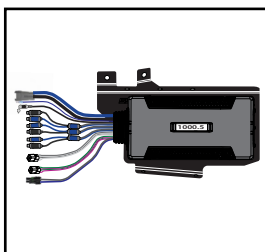

Amp Tray (B-A3450)  
pre-loaded with Kicker  
1000.5 Amp



Body Bracket  
(B-H3451)



M6 x 12 Screw  
{B-HPM612HH-3}



RZ5 Subwoofer Adapter  
Harness {B-H2276}



2-Pin Subwoofer Extension  
Harness {B-H3074K}

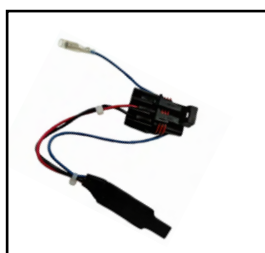

RZ5 Anti-Pop Harness  
{B-H2917}

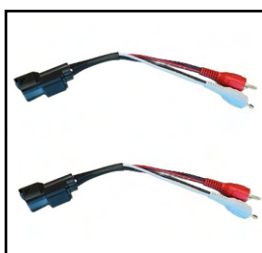

4 Pin to RCA Male Plugs x2  
{B-H3543}

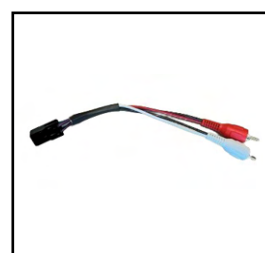

4 Pin to RCA Male Plugs  
{B-H3545}

# AMP PLATE INSTALLATION

1. POWER INPUT - Connect to B-H1587 Amp power harness
2. AMP TURN-ON - Connect to B-H2917 Anti-Pop Circuit Turn-On Wire
3. SUB BASS LEVEL - Plug to 240-PXA-SLC Bass Knob (Sold separately)
4. RCA AUDIO INPUT (AMP1) - Plug to B-H3543
5. RCA AUDIO INPUT (SUB L/R) - Plug to B-H3545
6. RCA AUDIO INPUT (AMP 2) - Plug to B-H3543
7. OUTPUT (FRONT) - Connect to Front Speaker harness
8. OUTPUT (REAR) - Connect to Rear Speaker Extension Harness
9. OUTPUT (SUB) - Connect to B-H3074K Sub Extension Harness

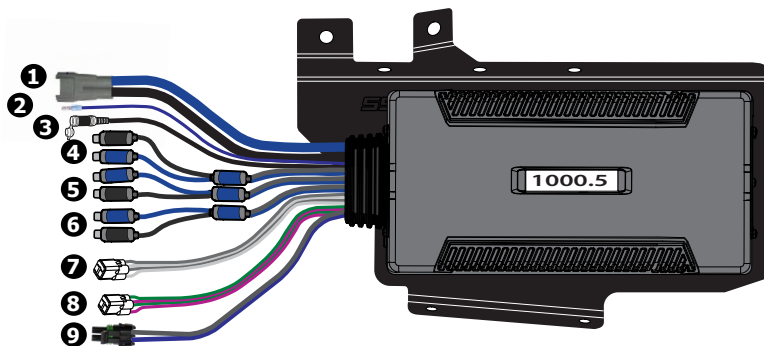

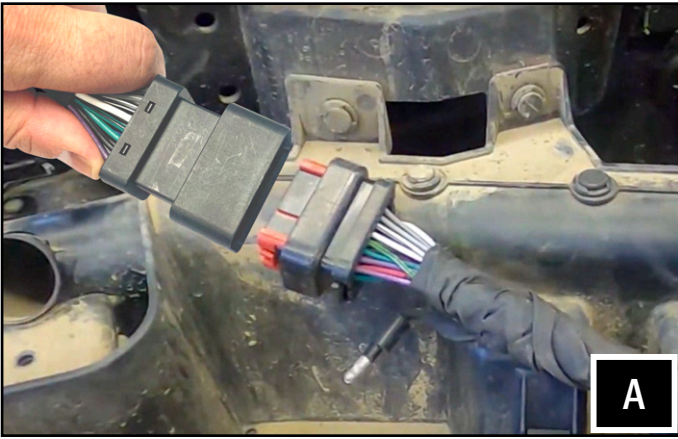

A. The factory amplifier is located under the plastic tray behind the radio. Unplug the factory amplifier 16 pin connector and plug it to the B-H2591 RZR Pro amplifier bypass harness. The factory amplifier is not used in this application.

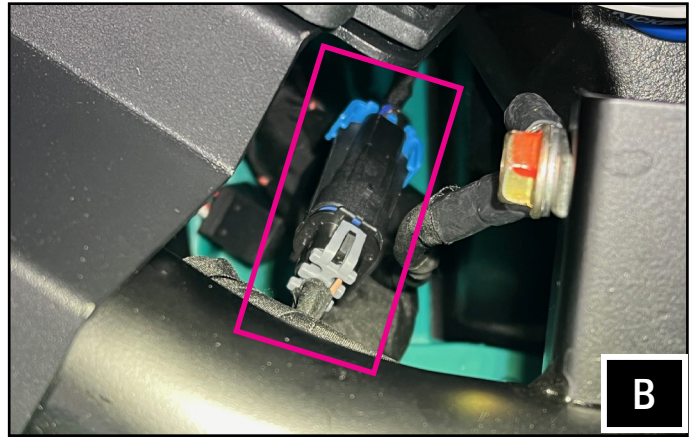

B. Locate the 4 pin Ride Command radio subwoofer output connector and plug it to the subwoofer adapter harness (B-H2276).

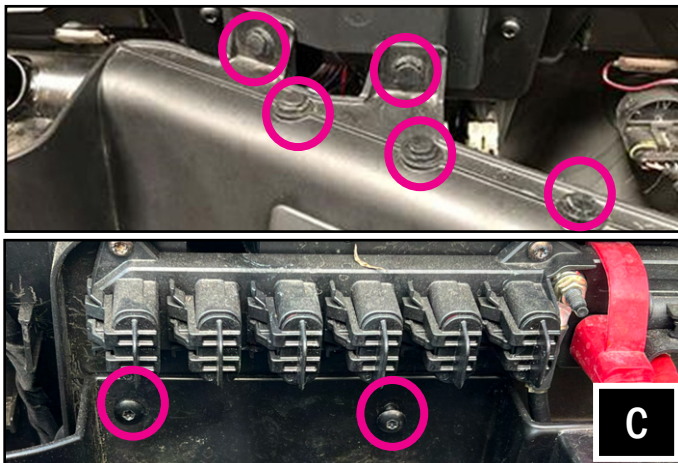

C. Remove the (5) push pins located on the plastic tray behind the radio. Extract (2) T25 screws located at the back of the plastic tray and below the bus bar, once extracted remove the plastic tray. Set aside the screws. The plastic tray will not be used in this installation.

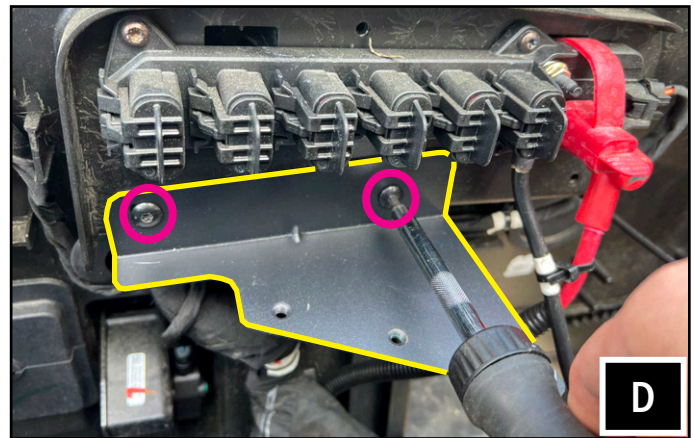

D. Attach the body bracket (B-A3451) under the bus bar using the factory screw bosses and T25 screws.

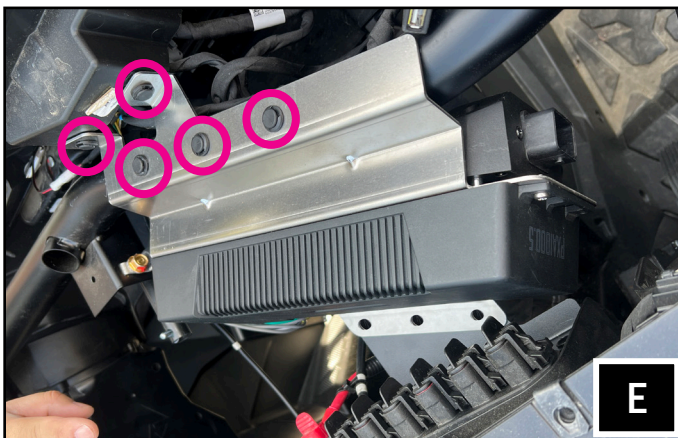

E. Line up the amp tray with the push pin holes and reuse the factory push pins to secure the amp tray.

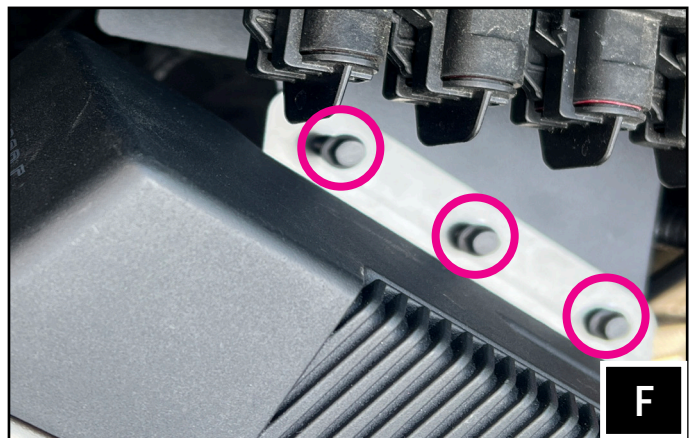

F. Secure the amp tray to the body bracket using the provided M6x12mm screws.

# ANTI-POP CIRCUIT CONNECTION

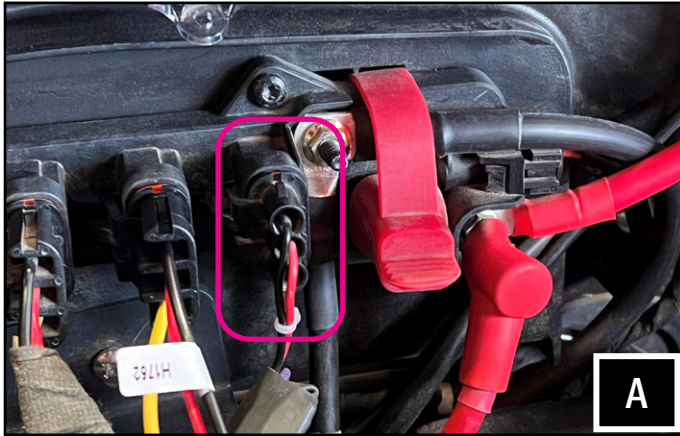

A. Plug the Anti-POP circuit (B-H2917) to a unused Pulse connector port on the busbar.



B. Plug the blue Amp Turn on wire of the Anti-Pop circuit to the Kicker amplifier amp turn-on wire.

To vehicle factory busbar  
Pulse connector

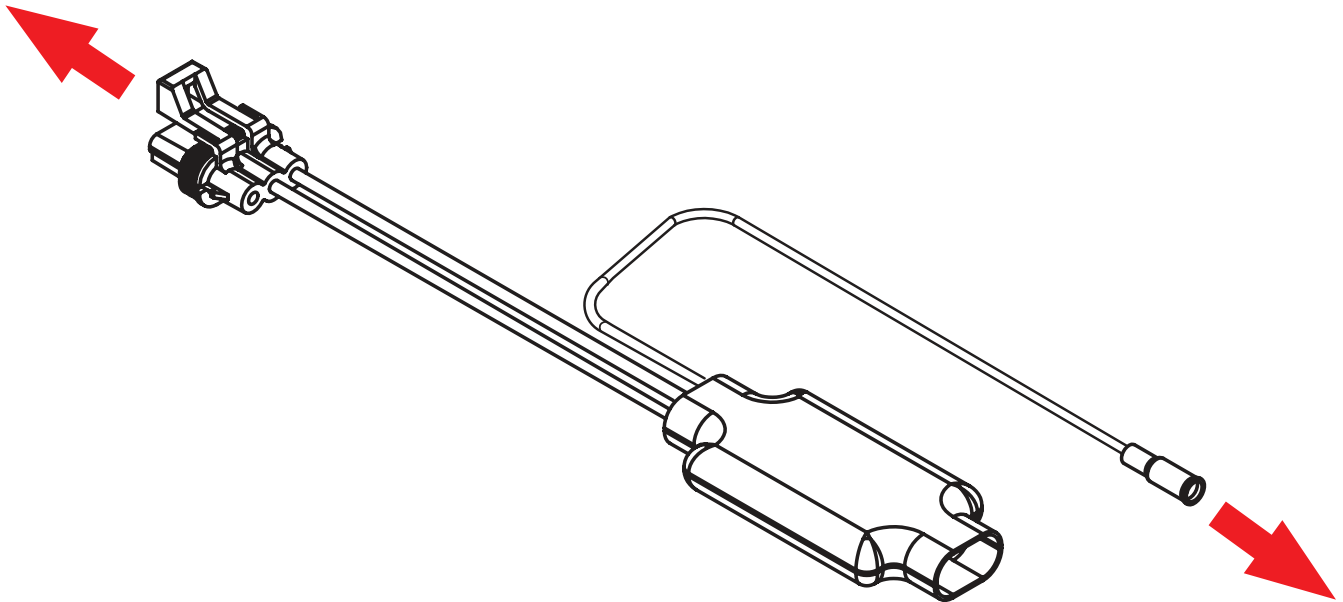

To Kicker Amp Blue  
Turn-On Wire

# AMPLIFIER WIRING DIAGRAM

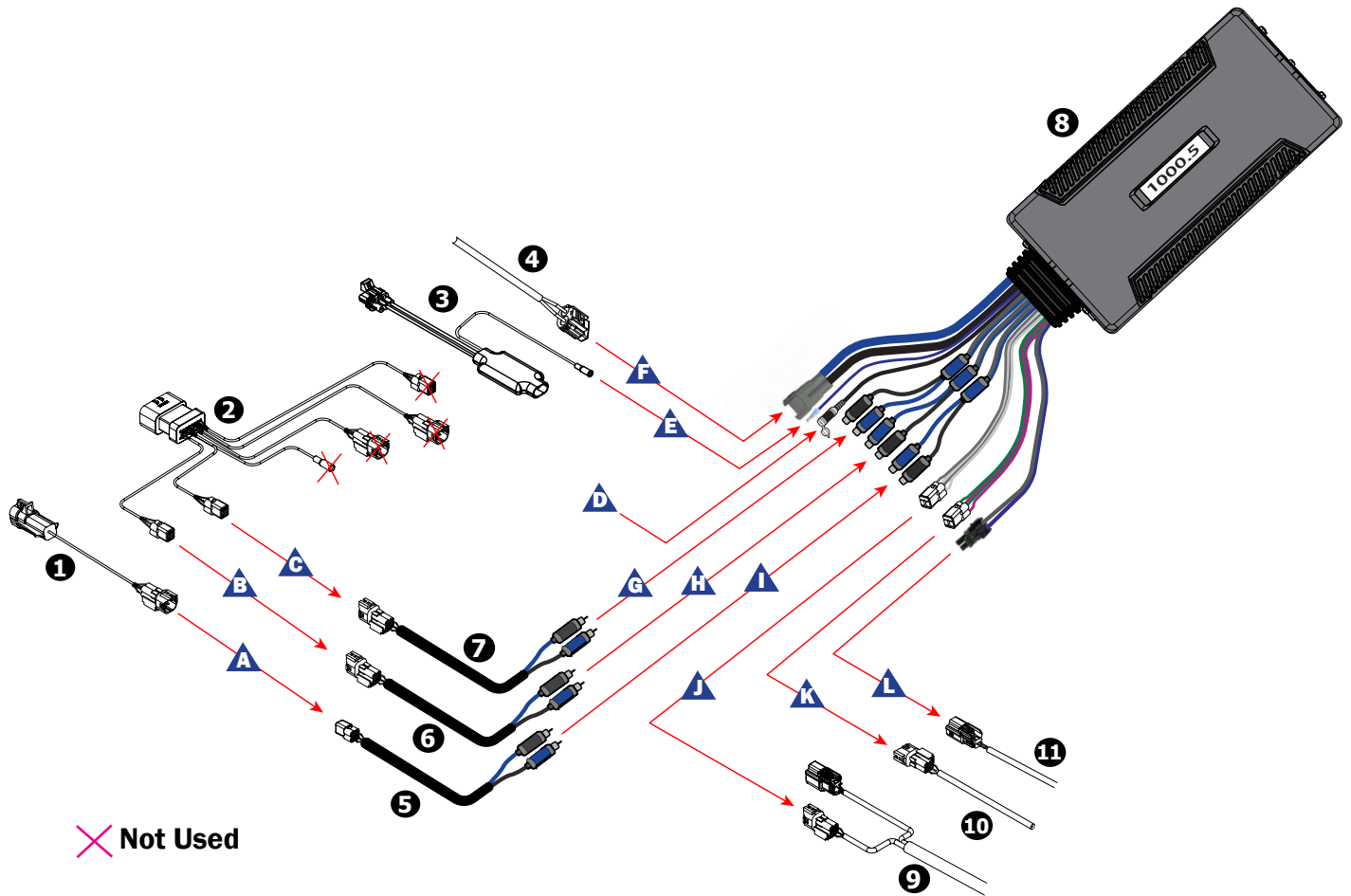

	Description	Part #
1	RZ5 Subwoofer Adapter Harness	B-H2591
2	RZ5 Factory Harness Amplifier Bypass Harness	B-H2276
3	RZ5 Amplifier Anti-POP Circuit	B-H2917
4	Amp Wiring Kit Assembly, 10 ft.	A-H1Q
5	4 Pin Female to Male RCAs Adapter	B-H3545
6	4 Pin Male to Male RCAs Adapter	B-H3543
7	4 Pin Male to Male RCAs Adapter	B-H3543
8	Kicker PXA1000.5 Amplifier RGB Extension, 2 ft.	SD-PXA10005
9	Audio/RGB Front Speaker Harness, 4 ft.	B-H2935
10	4-Pin Audio Extension Harness, 8 ft.	B-H1913
11	2-Pin Sub Extension Harness	B-H3074

Detail	Description
A	Plug RZ5 Subwoofer Adapter Harness to 4 Pin to RCA Adapter (B-H3545)
B	Plug Front Output to 4 Pin to RCA Adapter (B-H3543)
C	Plug Rear Output to 4 Pin to RCA Adapter (B-H3543)
D	Plug to 240-PXA-SLC Bass Knob (sold separately)
E	Plug to Amplifier Turn-On Wire
F	Plug to Amplifier Power Connector
G	Plug Male RCA to Amplifier Front Input
H	Plug Male RCA to Amplifier Rear Input
I	Plug Male RCA to Amplifier Subwoofer Input
J	Plug Amplifier Front Output to Audio Front Speaker Harness (B-H2935)
K	Plug Amplifier Rear Output to 4-Pin Audio Extension Harness (B-H1913)
L	Plug Amplifier Sub Output to 2-Pin Sub Extension Harness (B-H3074)

# RGB LED CONTROLLER COMMAND CENTER PARTS LIST

## WARRANTY INFORMATION:

All SSV Works enclosures are covered by a limited lifetime warranty against defects in material or workmanship. All SSV Works Electronics are covered by a limited 1 year warranty against defects in material or workmanship. Labor for replacement of defective components is not covered. Contact SSV Works for further warranty information.

## PARTS LIST IMAGES



LIT-CC, 3 Output, RGB LED Controller Command Center



LIT-CC RGB LED Controller Rocker Switch

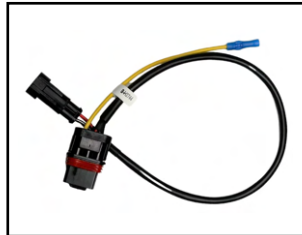

Pulse Power Harness [B-H2744]

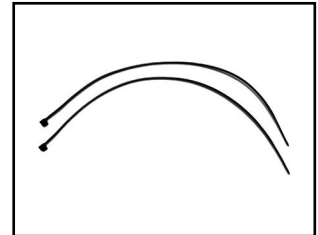

Zip Ties (x2)

## NOTE:

Includes 1 Universal Controller Pigtail for Output 3

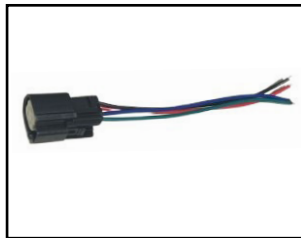

# RGB LED CONTROLLER COMMAND CENTER INSTALLATION

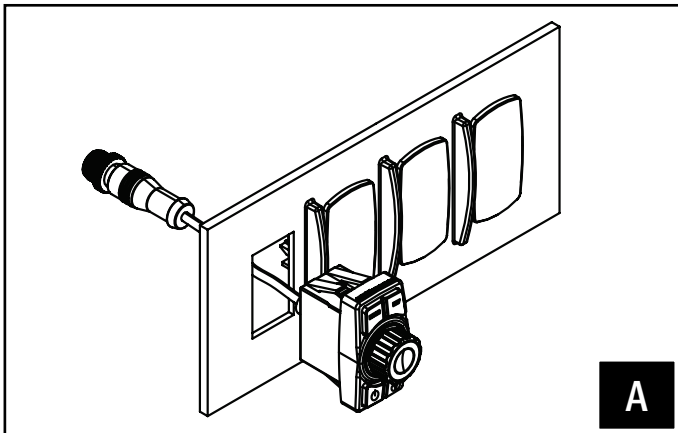

A. Install the LIT-CC RGB LED Controller Rocker Switch in an unoccupied rocker switch opening.

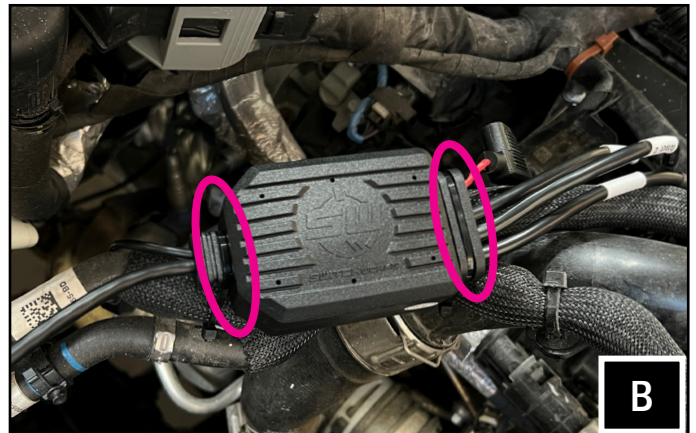

B. Mount the LIT-CC RGB LED Controller Command Center in the dash away from moving parts and secure with zip ties.

# RGB LED CONTROLLER COMMAND CENTER WIRING DIAGRAM

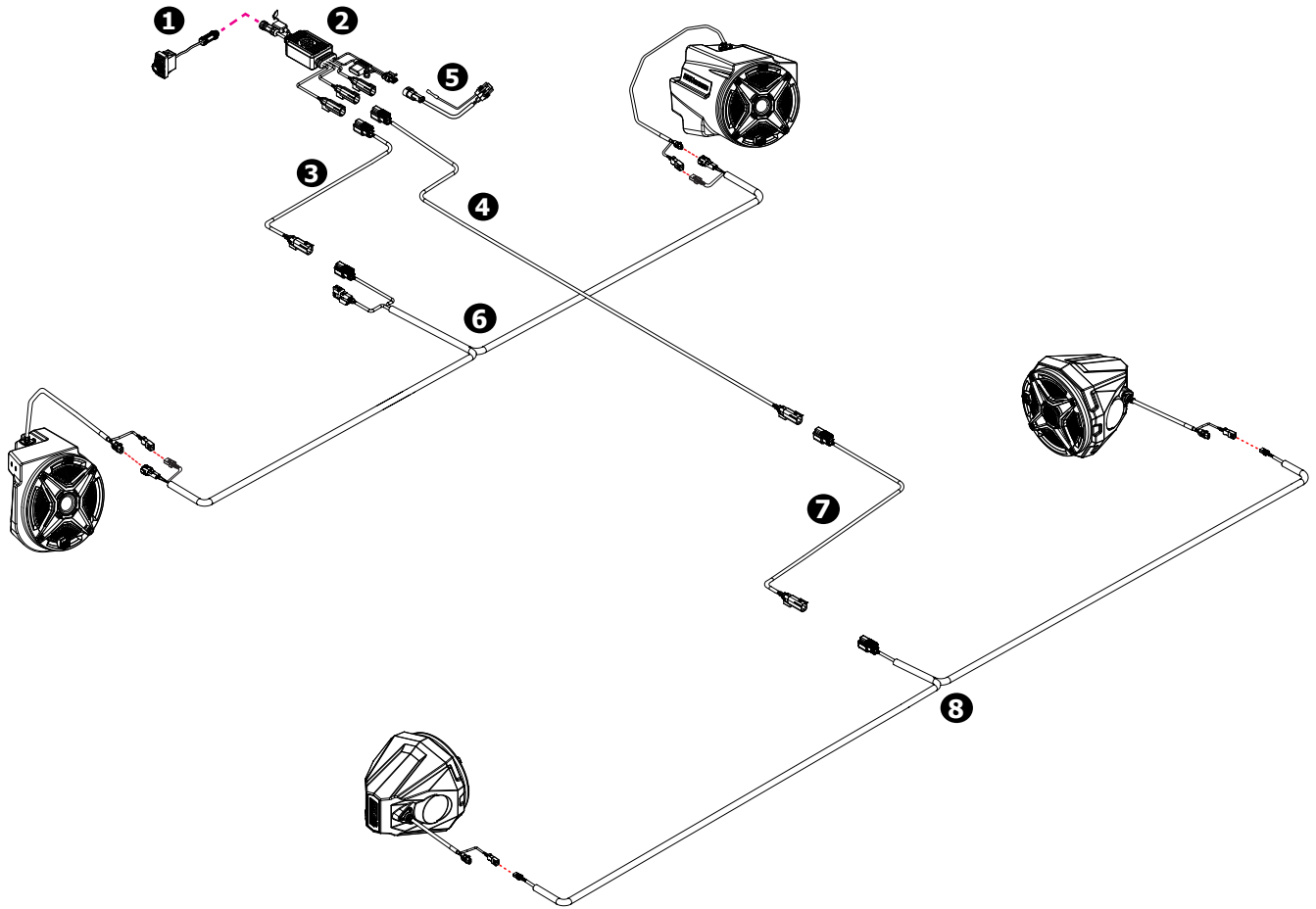

	Description	Part #
①	RGB LED Controller Rocker Switch for 230-LIT-CC	230-LIT-CC
②	SWITCH Works RGB LED Controller Command Center	
③	RGB Extension, 2 ft.	B-H2934
④	RGB Extension, 8 ft.	B-H2934
⑤	230-LIT-CC Pulse Connector Power Harness	B-H2744
⑥	RGB Front Speaker Harness, 4 ft.	B-H2935
⑦	RGB Extension, 2 ft.	B-H2934
⑧	Rear RGB "Y" Harness, 7 ft.	B-H2936

# RGB LED CONTROLLER COMMAND CENTER GENERAL OPERATIONS

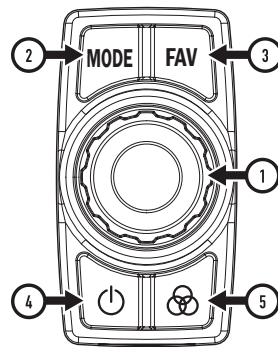

1. Select
2. Mode/Speed
3. Favorite/Preset
4. Power On/Off
5. Color/Brightness

## Power On/ Off:

- Press button to power unit on. Press and hold button for 2 sec. to power off. RGB ring around the knob illuminates when powered on.

## Output 1 On/Off:

- Quick press power button to turn output 1 on or off.

## Mode/Speed:

### Mode:

- Quick press Mode button and the Mode Button LED blinks to indicate it is ready to cycle through modes. Turn the knob to cycle through the different modes. Once the correct mode has been identified, quick press the knob to select the mode to write to memory. Mode Button LED will stop blinking.

### Speed:

- Press and hold Mode button for 2 sec. LED Ring will flash 3 times and Mode button will blink to indicate it is ready to cycle through speeds. Turn the knob to cycle through the different speeds. Once the correct speed has been identified quick press the knob to select the speed and write to memory. Mode Button LED will stop blinking.

## Color/Brightness:

### Color:

- Quick press the RGB icon button and the RGB icon LED will flash when ready to adjust. Turn the knob to cycle through the different color options. Once the correct color has been identified quick press the knob to select the color and write to memory. RGB icon LED will stop blinking.

### Brightness:

- Press and hold the RGB icon button for 2 sec. The RGB icon LED will flash when ready to adjust. Turn the knob to cycle through the different brightness levels. Once the correct brightness has been identified quick press the knob to select the brightness and write to memory. RGB icon LED will stop blinking.

## Favorite Preset:

- Quick press the FAV button to enter the Favorite mode. FAV button will flash when ready to cycle through 2 different presets. LED Ring changes colors to identify which preset is currently selected.

PRESET 1 = LED GREEN

PRESET 2 = LED CYAN

- To program your favorites, press and hold the FAV button for 2 seconds. The FAV button will start blinking. The LED ring will show current FAV preset (Green or Cyan). Press Mode button to select mode (Glow, Solid Color, Strobe, etc.); change colors, speed and brightness using their corresponding buttons. Select which FAV to save to (Green or Cyan). Press knob to save Fav. Press knob again to exit programming mode.

# UNDER DASH SUBWOOFER ENCLOSURE PARTS LIST

## PARTS LIST IMAGES



230-RZ5-UD10V Enclosure

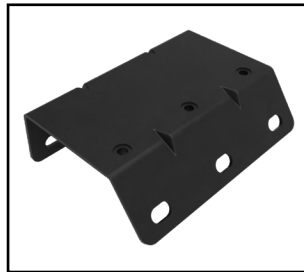

Base Bracket

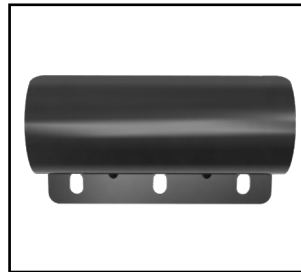

Clamp Bracket



M6x1.0x12mm x9



M6x1.0x40mm x2



M6 washers x11



M6 Speed Clips x2

# UNDER DASH SUBWOOFER ENCLOSURE ASSEMBLY

## TOOLS NEEDED FOR INSTALLATION

- Torx Driver T25 T30 T40

- Torx Driver T25 T30 T40

- Panel removal tools



A. Secure the base bracket to the enclosure with (6) M6x1.0x12mm T30 screws and washers.

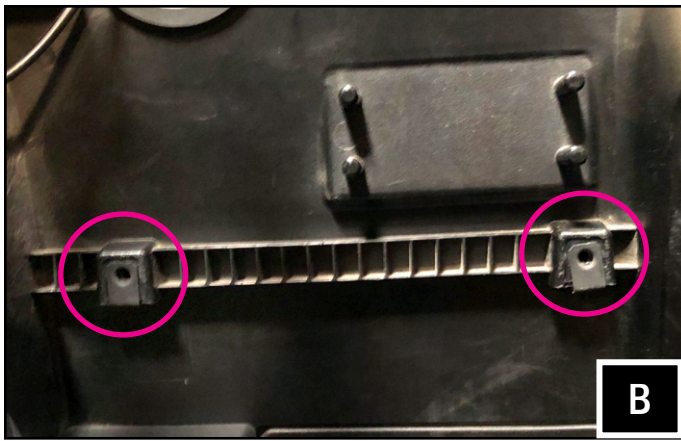

B. Slip on (2) M6 speed clips onto the specified locations of the firewall.



C. From the Passenger footwell, lift the 230-RZ5-UD10V into the dash cavity.



D. The top of the enclosure will tuck under the chassis cross bar. The bottom of the enclosure will rest above this edge of the firewall.



E. Apply force to the bottom of the enclosure to swing it into place. Once it is in place the lower mounting points will be in-line with the (2) M6 clip nuts.

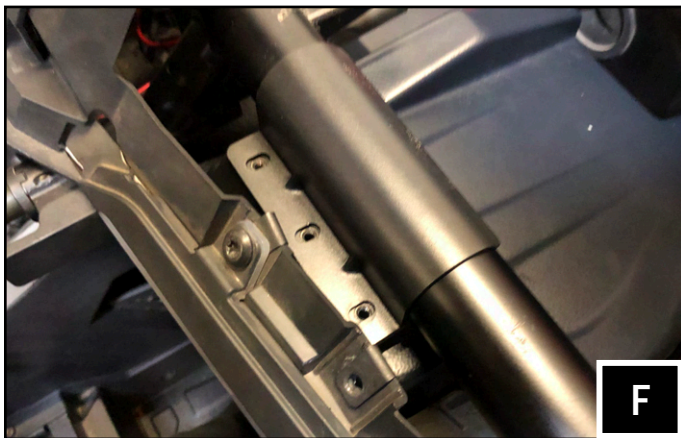

F. Place the clamp bracket over the chassis and base mounting bracket. Secure the clamp bracket to the base bracket with (3) M6x1.0x12mm T30 screws and washers.

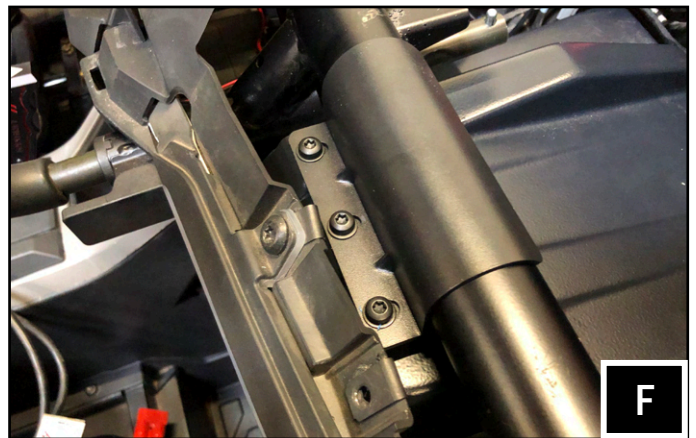



G. Secure the bottom of the enclosure with the provided M6x1.0x40mm T30 screws and washers to the M6 clip nuts attached to the firewall.

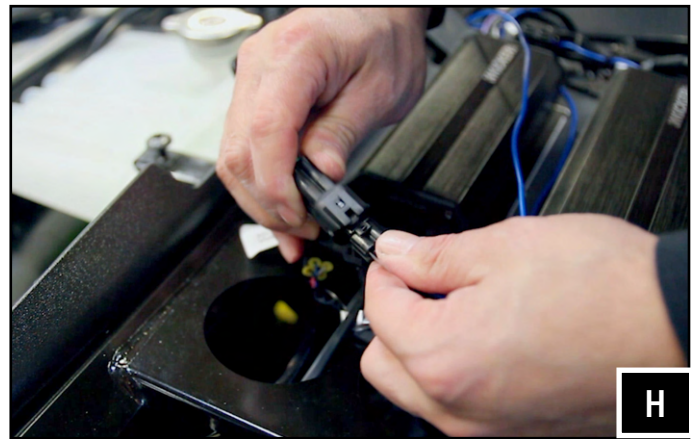

H. Connect the subwoofer cable to the 500.1 amplifier output.

## UNDER DASH SUBWOOFER WIRING DIAGRAM

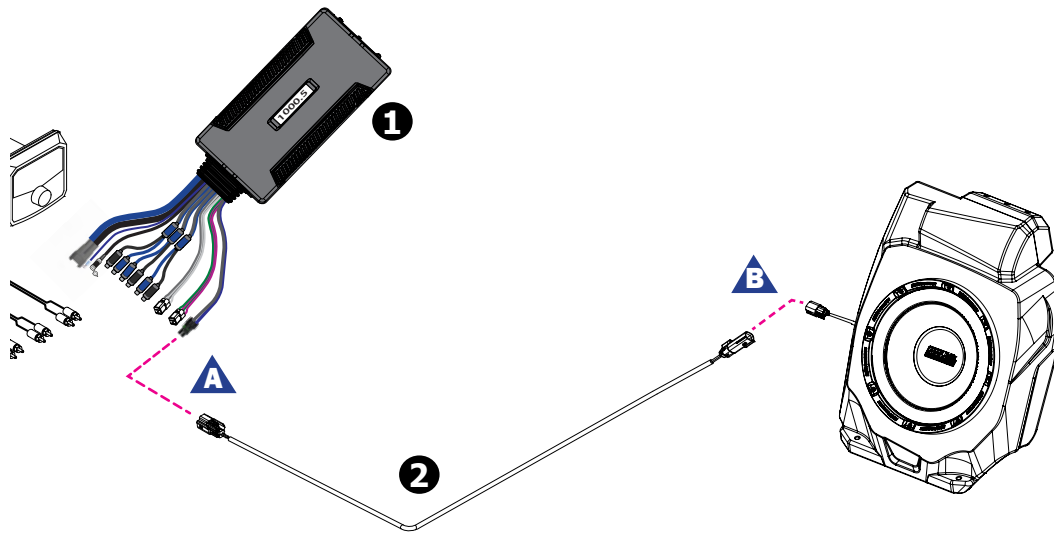

	Description	Part #
1	Kicker PXA10005 Amplifier	SD-PXA10005
2	2-Pin Audio, Sub Extension Harness	B-H2702
3	Loaded Under Dash Sub, 10" 2 ohms	230-RZ5-UD1

Detail	Description
A	Plug Subwoofer Output to B-H2702
B	Plug B-H2702 to the Subwoofer

## CONNECTING AMPLIFIER POWER & GROUND CABLE TO BATTERY

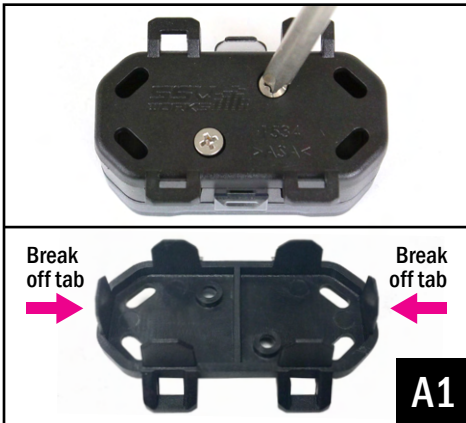

A1. Remove the bottom cover of the fuse holder by extracting the 2 screws. Break off the right and left side tabs on the bottom cover.

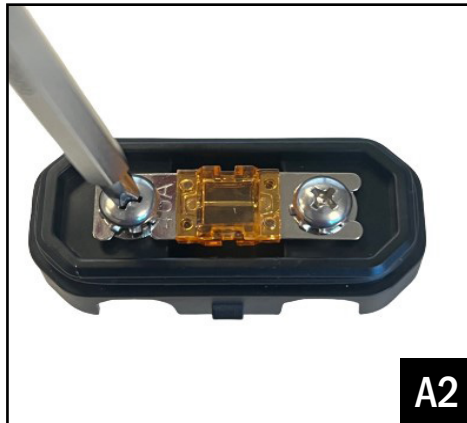

A2. Extract both fuse holder screws and fasten the fuse.

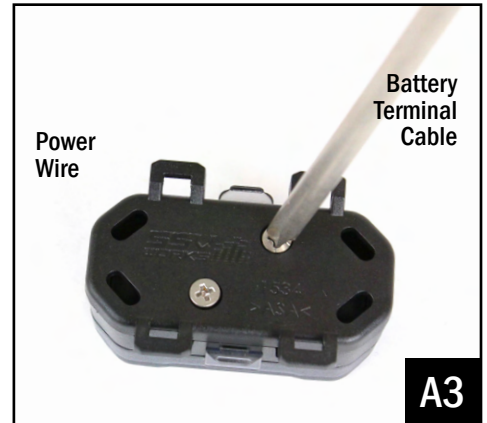

A3. Attach both the Power Wire and Battery Terminal Cable to the fuse holder. Reattach the bottom cover.



B. Unscrew the factory nut on the negative battery terminal. Install the 2 ground cables to the screw on the ground battery terminal. Re-install the factory nut.



C. Unscrew the factory nut on the positive battery terminal. Install the 2 power cables to the screw on the positive battery terminal. Re-install the factory nut.



D. Remove the top of the fuse holder and extract the 2 screws. Insert the 40A fuse, screw the 2 screws back in and reattach the fuse holder top.



E. Zip tie all of the electrical cabling (factory and audio) along the center column away from the drive shaft.

# SPEAKER DASH POD PARTS LIST

## PARTS LIST IMAGES



Speaker Dash Pod, Drive Side



Speaker Dash Pod, Passenger Side



SSV Works V-Spec Speakers  
(pre-mounted)



2mm Self Adhesive Speaker Gasket  
(x2)



Driver and Passenger Side Brackets



T Brackets



P and D Bracket Hardware Pack,  
M6x12mm [B-HPM612-4]

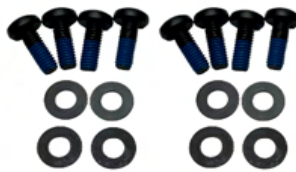

T Brackets Hardware Pack, M6x16mm  
[B-HPM616-4C]



#14 x .75" Phillips Screw  
[B-HP#14-4]



M6x1 x 16mm Screw and Washer Pack  
[B-HP3503]



#7x1.25" Speaker Screw Pack  
[B-HP#7-8]

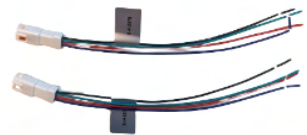

RGB Pigtail [B-H3380]

# SPEAKER DASH POD INSTALLATION

## TOOLS NEEDED FOR INSTALLATION

- T30 Torx Driver

- Phillips Screw Driver



A. Start by removing the front fenders.



B. Remove the screw holding the door latch panel.

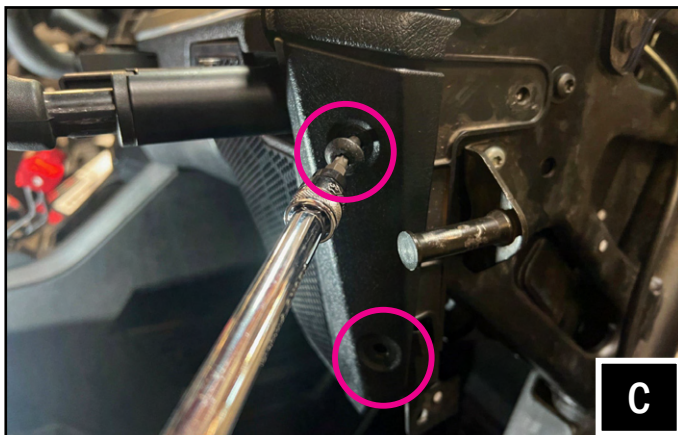

C. Remove the factory speaker grill by removing the (2) screws on the side.



D. Attach the self adhesive speaker gasket and mount the speakers to the dash pods using (8) #7x1.25" screws [B-HP#7-8].

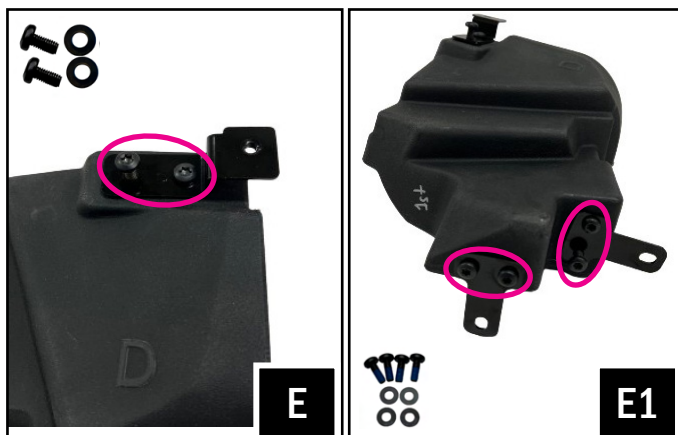

E. Secure the "D" bracket to the drive side dash pod using (2) M6x12mm screws and washers [B-HPM612-4].

E1. Use (4) M6x16mm screws and washers [B-HPM616-4C] to secure the T-brackets.

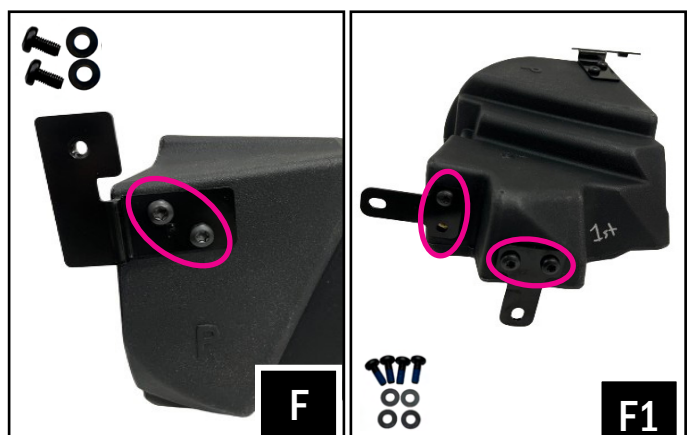

F. Secure the "P" bracket to the passenger side dash pod using (2) M6x12mm screws and washers [B-HPM612-4].

F1. Use (4) M6x16mm screws and washers [B-HPM616-4C] to secure the T-brackets.

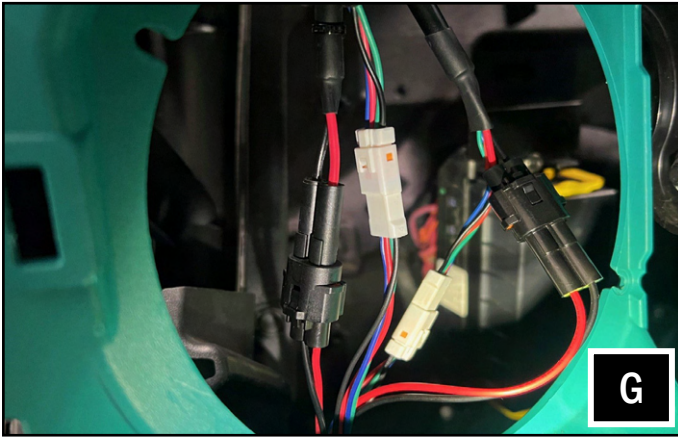

G. Plug the B-H3601 Tweeter Pod Expansion harness to B-H2935 Front RGB/Audio speaker harness.

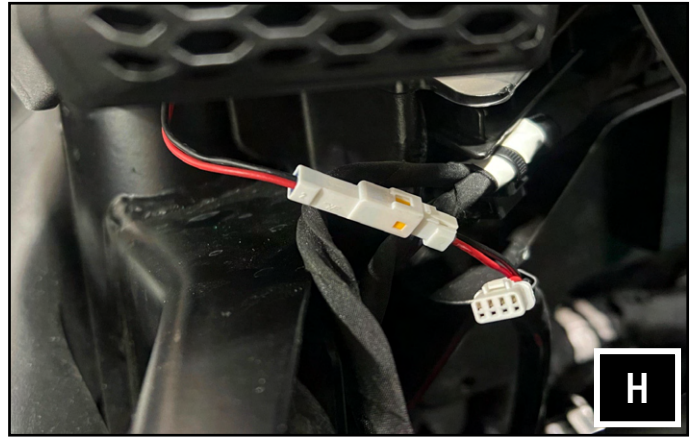

H. Plug the 2 Pin connector of B-H3601 to the factory tweeter connector.

### Factory Tweeter Retention Wiring Connection

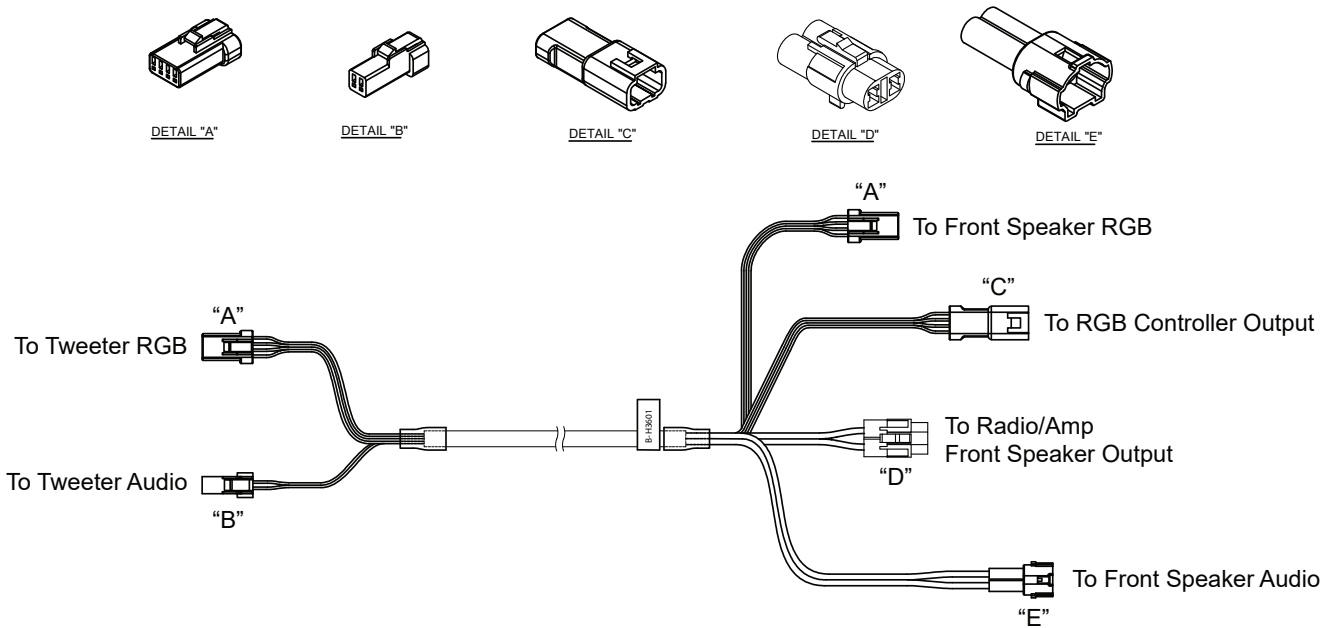

I. Slide up the RZR kick pod under the dash.



J. Secure the T brackets of each pod to the factory bosses on the footwell using (2 each) #14x.75 phillips screws [B-HP#14-4].

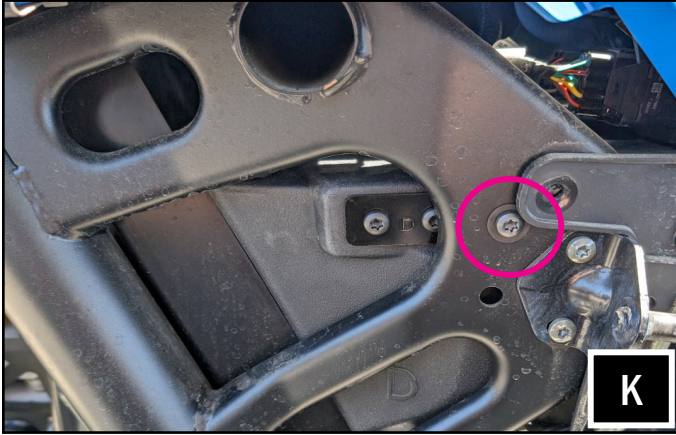

K. Secure the D (driver) and P (passenger) pod brackets to the vehicle frame using (2) M6x16 screws [B-HP3503] circled above.

**\*\*\*Test the system for functionality before reassembling the panels\*\*\***



L. Reinstall the factory driver and passenger side speaker grill using the factory screws. Reinstall the front fenders.



M. Completed installation of driver and passenger side of SSV Works RZR 6.5" dash pods.

# REAR CAGE POD PARTS LIST

## PARTS LIST IMAGES



RZ5-DF65V Enclosures  
(1 pair)



Dual Mounting Clamp Base x 2



2" Ring Clamp x 4



M6x1.0x20mm (8mm Hex  
Head) Screws & Washers x4



M6x1.0x45mm (5mm Allen  
Head) Screws & Washers x4



M6x1.0x6mm (3mm Allen  
Head) Screws x4



B-H2195 Rear Speaker Harness



B-H1913 Speaker Extension  
Harness



4-Pin Extension Harness, 2 ft.  
(for 4 door models)



B-H2936 RGB "Y" Harness,  
7 ft.



B-H2933 RGB Extension, 8 ft.



B-H2934 RGB Extension, 2 ft.  
(for 4 door models)



Zip Tie Panel Post x5



Zip Ties

# REAR CAGE POD INSTALLATION

## INSTALLATION NOTES

It is recommended to wrap the bag that the clamps come in around the cage before you slide the clamp onto the cage to prevent scratching.

Placement of the pod depends on what type of roll cage you have (factory or aftermarket) and your preference of where you want the pods to be installed. In these instructions, we have installed them on the outside vertical bars at the back of the roll cage.



A. Find the best orientation for the speaker on your bar and screw in the Set Screws in the OPPOSITE holes of where the clamp will install into.



B. Loosely install the clamp base to the cage mount pod with the two (2) M6 hex head bolts and washers, place the cage mount pod in the desired mounting location on the vehicle. Once the ring adapter is in the desired position, tighten the two (2) bolts using a 8mm open wrench.

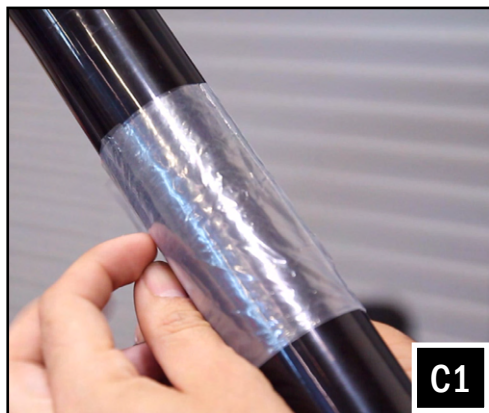

C1. Place both ring mounting clamps on the cage using the plastic bag to prevent scratching.

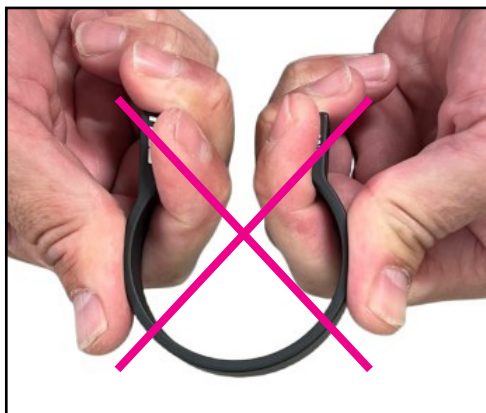

**DO NOT FORCE OPEN THE CLAMPS!**

SSV Works Tension Clamps are designed to grip tightly onto the tube.



C2. Press the clamps onto the roll cage over the plastic bag.



D. Place the cage mount pod in its final mounting location and secure to the clamps using the two (2) M6 allen socket head bolts and washers with a 5mm allen key.



E. Take the B-H2195 rear speaker harness and plug into the B-H1913 (add B-H1912 for 4 door models) rear extension harness. Plug the B-H2936 RGB "Y" harness to B-H2933 (add B-H2934 for 4 door models) RGB extension harness.



F. Position the speaker to your liking and tighten the hex head bolts by hand with a 8mm wrench.



G. Take the B-H2195 rear speaker harness and plug into the B-H1913 (add B-H1912 for 4 door models) rear extension harness. Plug the B-H2936 RGB "Y" harness to B-H2933 (add B-H2934 for 4 door models) RGB extension harness.

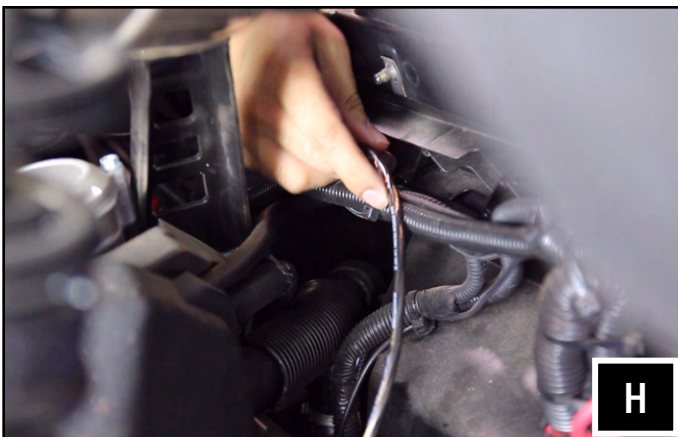

H. Route the rear speaker harness (B-H2195) and RGB harness (B-H2936) along the factory wires in the engine compartment and pull up through the small space between the bed panel and cage tubing on both passenger and driver sides. Plug in the connectors to the cage pods. Run the other end of the audio extension harness to the amplifier location and the RGB extension harness to the LIT-CC location.

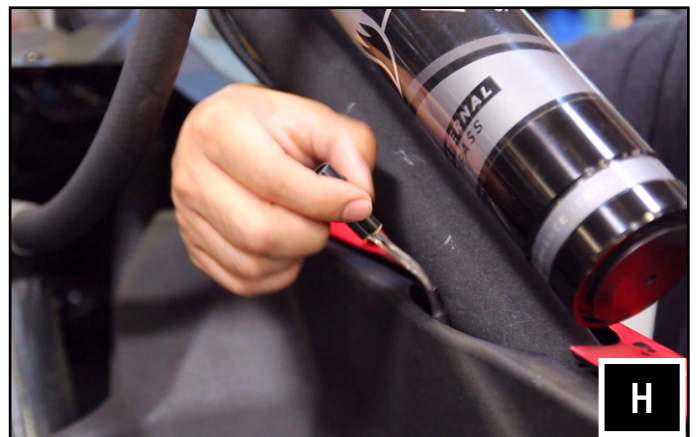

**\*\*\*Test the system for functionality before reassembling the panels\*\*\***

# REAR SPEAKER PODS WIRING DIAGRAM

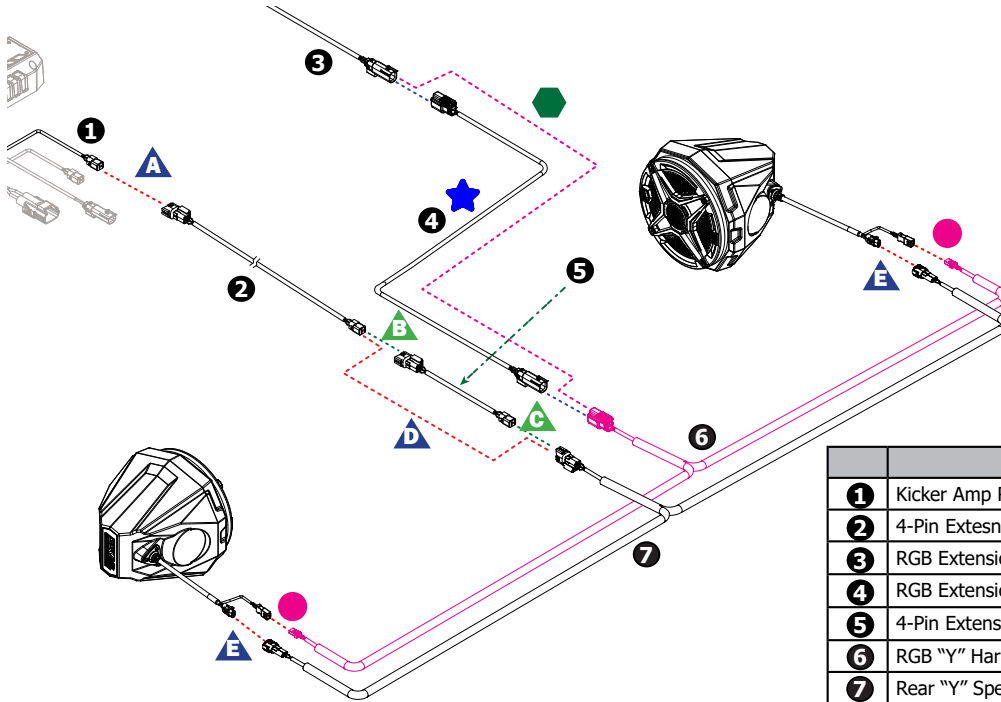

	Description	Part #
1	Kicker Amp Rear Output	
2	4-Pin Extension Harness, 8 ft.	B-H1913
3	RGB Extension Harness, 8 ft.	B-H2933
4	RGB Extension Harness, 2 ft. (for 4 door models)	B-H2934
5	4-Pin Extension Harness, 2 ft. (for 4 door models)	B-H1912
6	RGB "Y" Harness, 7 ft.	B-H2936
7	Rear "Y" Speaker Harness, 7 ft.	B-H2195

Detail	Description (RGB Connections)
★	Add the B-H2934 2 ft. RGB Extension for 4 door models
⬡	Plug the 8 ft. B-H2933 RGB Extension harness to B-H2936 for 2 door models
●	Plug the B-H2936 RGB Rear "Y" Harness to the Left and Right Cage Pods

Detail	Description (Audio Connections)
▲	Connect Kicker Amp Rear Output to B-H1913
▲	Connect B-H1913 to B-H1912 (for 4 door models)
▲	Connect B-H1913 to B-H2195 (for 4 door models)
▲	Connect B-H1913 to B-H2195 (for 2 door models)
▲	Plug the B-H2195 to the Left and Right Cage Pods

**THANK YOU!**

We are committed to your satisfaction and we know you will enjoy our products. If you have questions or need any assistance, please let us know.

 [SSVWORKS.COM](https://www.ssvworks.com)  
 1-818-991-1778 EXT 2  
 [SUPPORT@SSVWORKS.COM](mailto:SUPPORT@SSVWORKS.COM)

Returns must be made within 30 days of purchase date. Claims for missing items or items damaged in transit must be received within five business days of receipt of merchandise. All returns must be in original packaging and in re-sellable condition. Shipping fees are not refundable.