

Description:	Quantum® Hardcoated Polycarbonate UTV Windshield, Wash'n'Wipe™ Full Size	Model:	Polaris RZR 800, Round Tube
Part Number:	N30202	Installation Time:	60 min

Thank you for purchasing a National Cycle product. Read these instructions carefully and thoroughly before beginning work. Dealers, if installing this windshield for a customer, please give them this manual. It contains information needed to properly maintain and use this product.



Attention:
Special notes and cautionary measures which can prevent damage to the accessory or vehicle.



Note:
Tips for facilitation of operation, control and adjustment, as well as maintenance work.

PREPARATION

This Kit has been carefully packed and inspected at the factory. Report any missing part directly to National Cycle, Inc. along with the Bag No. and Date on outside of Windshield Carton.

Carefully unpack the windshield, sort the parts, and make sure you have everything required to complete the installation to the vehicle.

TOOL LIST

- Flat Blade Screwdriver
- T25 and T30 Torx Wrench
- X-Acto® Knife, or similar
- Punch
- Wire Cutters
- Power Drill with 3/4" (19mm) hole saw, or similar
- Small Drill Bit (1/8") (3mm) for pilot hole
- #2 or #3 Phillips Screw Driver or Phillips Bit for Drill

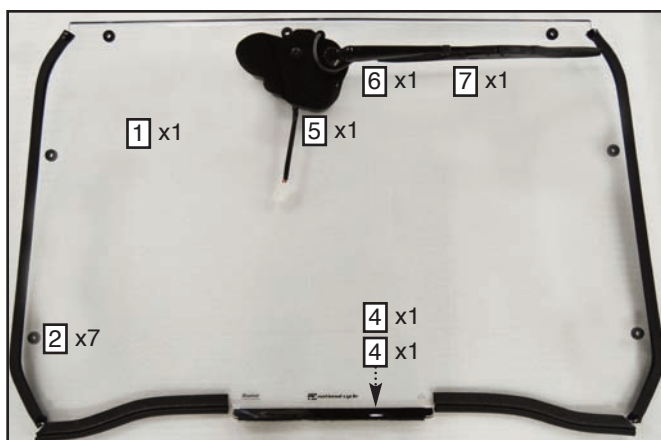

Parts Installed on Windscreen			Tools / Notes	
Item	Part No.	Description	Qty.	Tools / Notes
1	20-290396-000	Windscreen with Trim	1	
2	44-447165-000	Grommets for Windshield	7	Installed on Windscreen
3	77-771152-001	Marine Grade Velcro, Hook,.917' (27cm) L	1	Installed on Windscreen
4	77-771153-001	Marine Grade Velcro, Loop,.917' (27cm) L	1	Installed on Windscreen
5	80-875150-000	Motor, Assembly	1	Installed on Windscreen
6	80-875151-000	Arm, Wiper Assembly, 9.84" (250mm)	1	Replacement Arm Part No. is N30910
7	80-875154-000	Blade, Wiper Assembly, 14" (355.6mm)	1	Replacement Blade Part No. is N30900

Parts List Continues on Next Page

WIRE HARNESS

9 x1

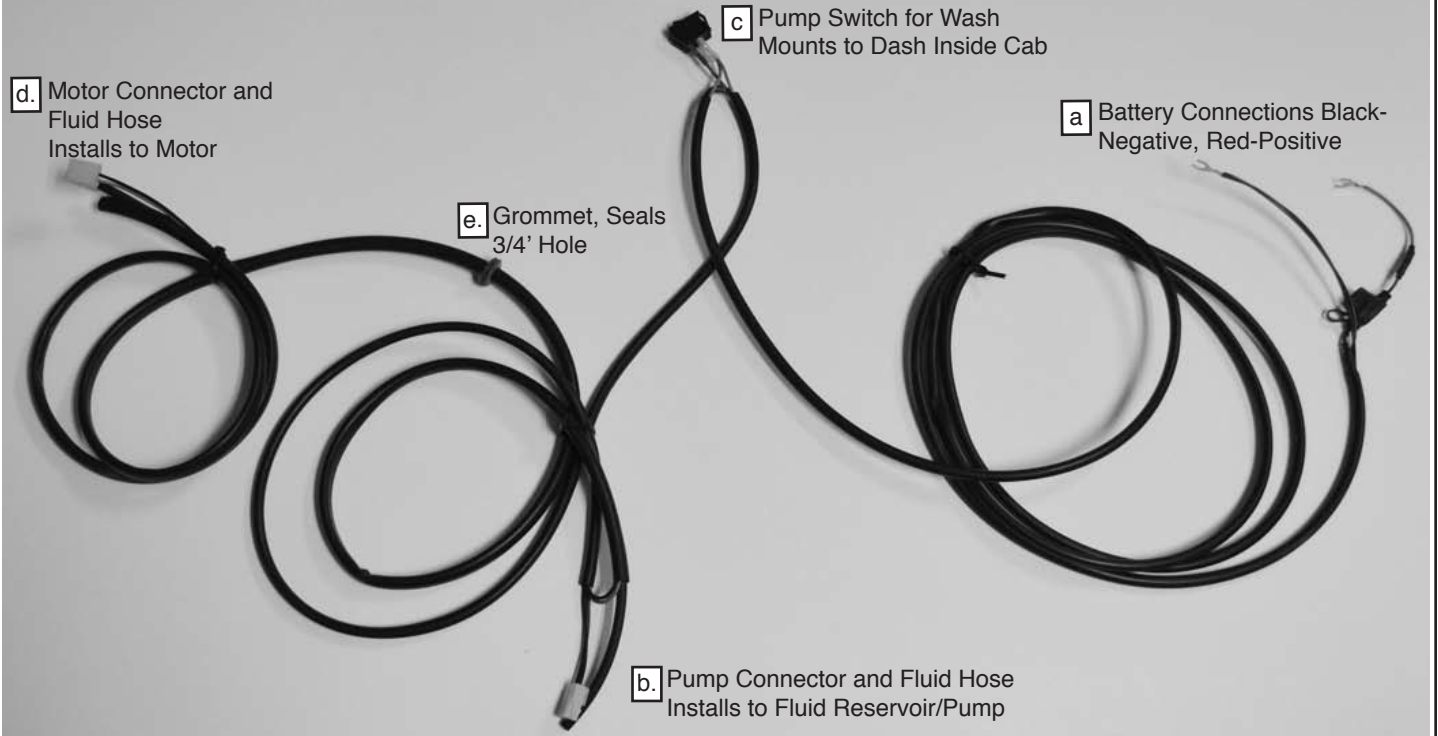

RESERVOIR

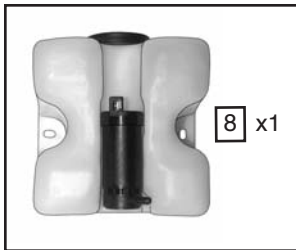

BAG#1174

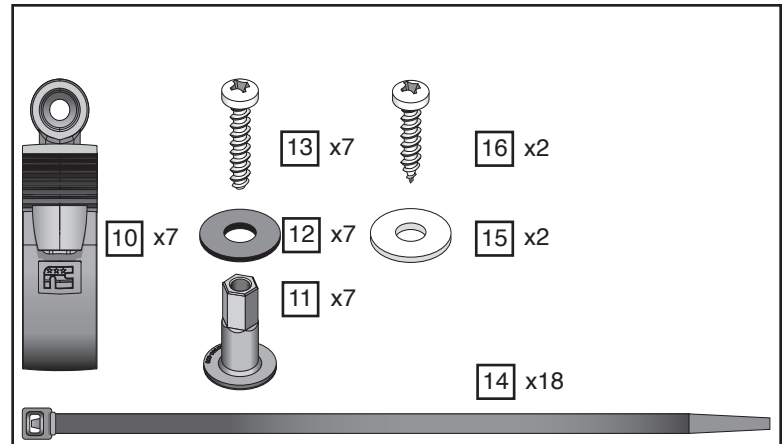

 Keep this page as a reference guide during the assembly process.

Parts Included in Kit

Tools Required

Item	Part No.	Description	Qty.	Notes and Tools
KIT				
8	44-442523-000	Reservoir & Pump Assembly	1	
9	80-830326-000	Wire Harness	1	With Grommet and Switch
Bag#1174				
10	44-449370-000	Clamp, Wraparound	7	
11	44-449380-000	Retaining Pin	7	
12	49-490355-000	Washer, Flat, Black	7	
13	55-563131-000	Screw, Phillips, #12 x 1.25", SS	7	#2 or #3 Phillips Screw Driver
14	44-448726-000	Zip-Tie, Black	18	
15	49-490543-000	Washer, Flat, .253 x .875 x .053"	2	
16	55-550260-000	Screw, Phillips, #12 x .75" SS	2	#2 or #3 Phillips Screw Driver

PREPARE THE VEHICLE FOR WIRING

REMOVE SEATS AND CENTER CONSOLE

1. Remove Seats.
2. Remove cap and handle from gear shifter.
Figure 1 (Flat Blade Screwdriver and T25 Torx)
3. Remove center console.
Figure 2 (T30 Torx)

 A piece of cardboard serves as a template to keep fasteners organized by location.

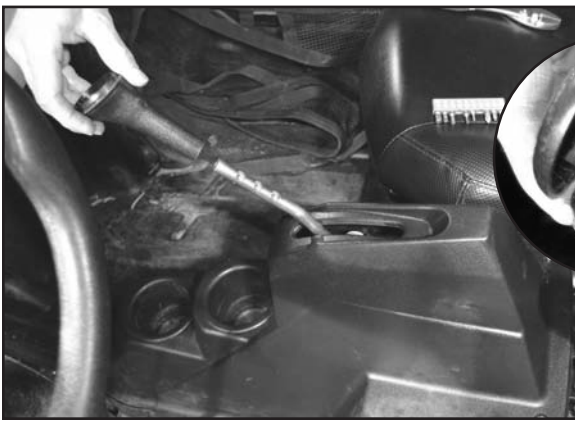
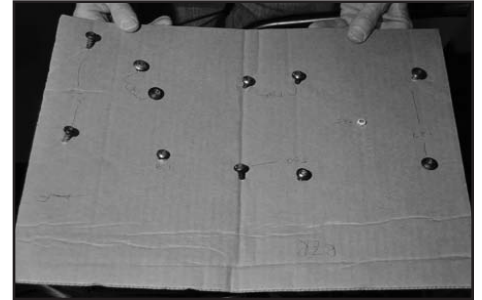



Figure 1



Figure 2



CUTTING THE PUMP SWITCH HOLE

 The installation of the Pump Switch on this vehicle is below the aftermarket light switch. Select your preferred location for the switch. Use care when cutting hole, avoid over cutting.

1. Disconnect the Pump Switch (c) from the main Wire Harness. Scribe or draw a 17/32" x 1 1/8" (13.5mm x 28.5mm) guide in the desired location.

Figure 3

2. Using a drill, drill some holes in the plastic cover to serve as starting holes for cutting. Then use your X-Acto® knife to cut out the cover's face to the edges. DO NOT OVER CUT.

Figure 3

CUTTING THE PASSWAY 3/4" HOLE

1. On the hood of the vehicle close to the left frame post, measure a point 4" (101.6mm) from the back of the dash and 1.125" (28.5mm) from the side of the raised area where frame drops into dash. Mark that location for center of the drill hole.

Figure 4

2. Insert a step drill bit into your drill as shown (or 3/4" hole saw) and drill a 3/4" (19mm) hole in the body cover at the location.

Figure 4 (Power Drill and 3/4" (19mm) Hole Saw)



Figure 3

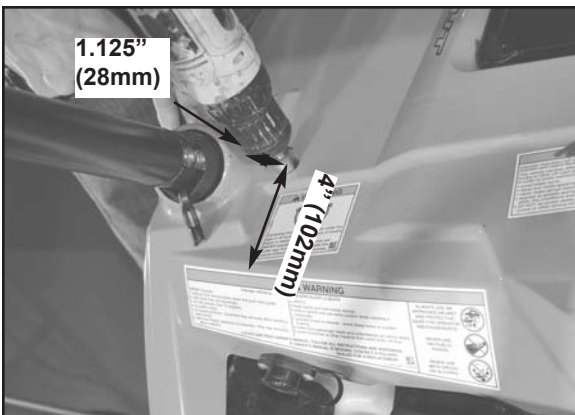



Figure 4

PREPARE THE VEHICLE FOR WIRING, Continued

MOUNT RESERVOIR/PUMP ASSEMBLY

 The installation of the Reservoir on this vehicle is in the lower left side of the driver's cab. If you prefer a different location you may use it.

1. Take the Reservoir/Pump Assembly (8) and position it on driver's side wall, inside the vehicle.

Figure 5

2. Using a marker, mark inside the holes of the Reservoir's mounting tabs.

Figure 5

3. Using a Scribe punch two holes at the locations marked.

Figure 5 (Scribe)

4. Mount the Reservoir to the side of the cab with Sheet Metal Screw (16) and Flat Stainless Washer (15).

Figure 5 (Phillips Screwdriver)

WIRE HARNESS INSTALLATION- PUMP CONNECTOR AND FLUID HOSE

Place the Wire Harness in the drivers foot well.

 1. Take Pump Connector and Fluid Hose section (b) of the Wire Harness and locate the terminus of the Rubber Hose and the Large Nylon 2-Pin Electrical Connector with red and black wires.

Figure 6

2. Take the Pump Connector section and fold it against the Rubber Hose section, as shown. Secure the two sheaths with a Zip-Tie (14) and trim the excess tie.

Figure 6 (Wire Cutters)

3. Connect the Rubber Hose to the bottom of the Reservoir's Electrical Pump.

Figure 7

4. Push the Nylon Quick-Connector onto the two pins on top of the Reservoir's Electrical Pump.

Figure 7

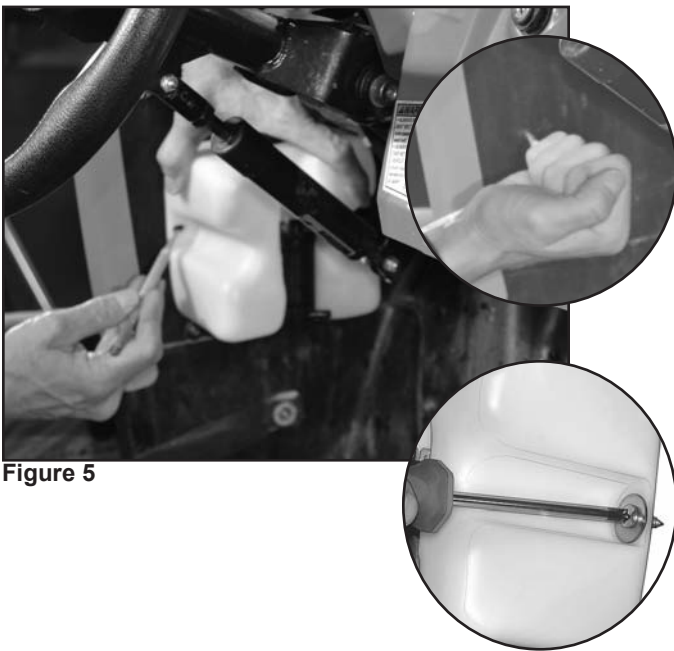

Figure 5

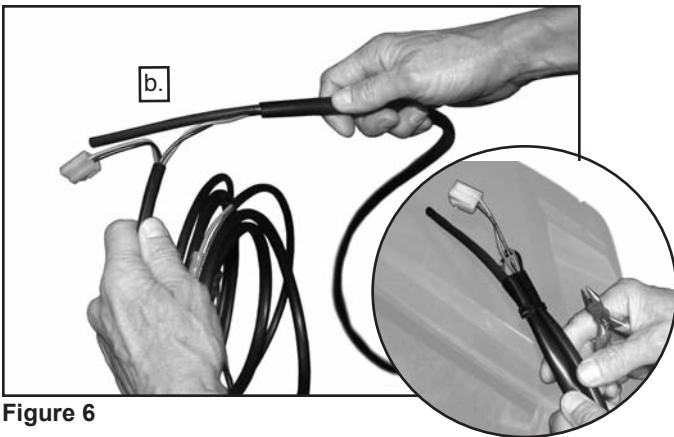

Figure 6

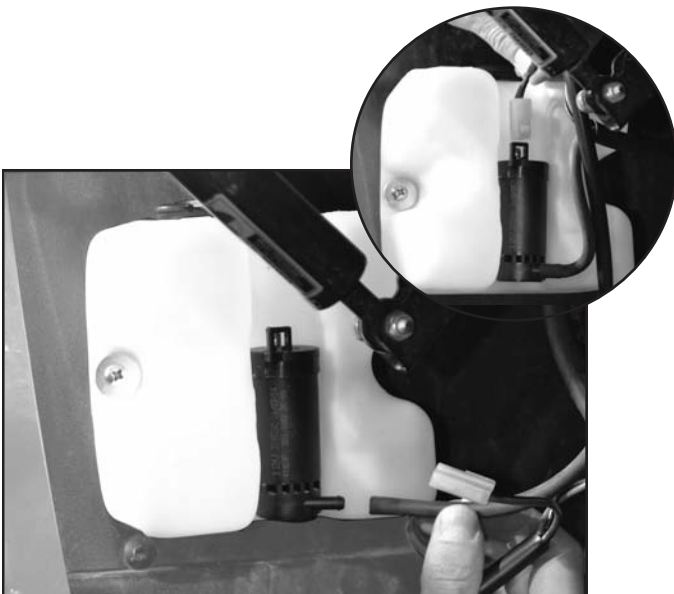

Figure 7

WIRE HARNESS INSTALLATION- MOTOR CONNECTOR AND FLUID HOSE

1. Find the Motor Connector and Fluid Hose section (d) of the Wire Harness and thread it through the 3/4" (19mm) hole cut into the vehicle's body.

Figure 8

2. Use the 5/8" Rubber Grommet (e) attached to the wire harness to plug the hole.

Figure 8

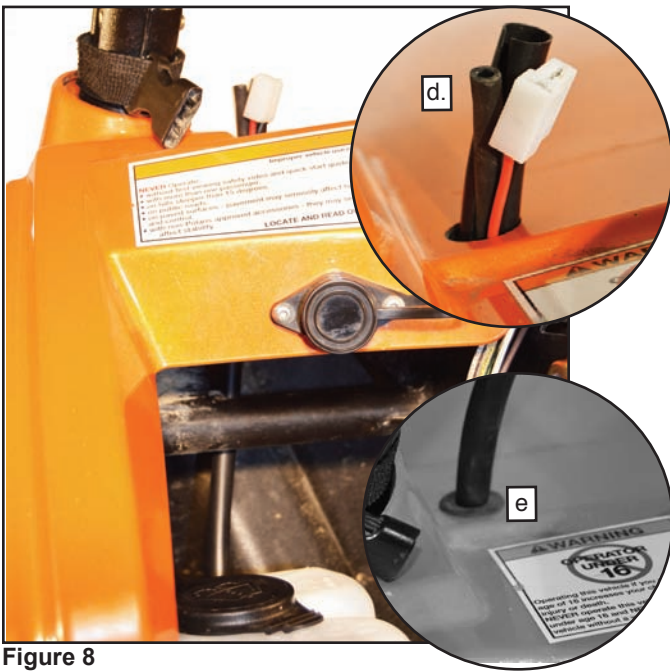

Figure 8

3. Follow the Frame Tube pulling enough length through the 3/4" (19mm) hole so terminus of Motor Connector (d) reaches 4-5" (10-12cm) past the half way point of the upper frame tube. This is where the Wash'N'Wipe Motor will be located.

Figure 9

WIRE HARNESS INSTALLATION- ROCKER SWITCH TO DASH

1. Locate the section of Wire Harness (c) that terminates in the Two-Way Rocker Switch. Temporarily remove the Rocker Switch and thread the wiring over the steering column toward the hole you cut in the dash.

Figure 10

2. Thread the Wire End (c) through the hole. Reattach the Two-Way Rocker Switch to the two Nylon Pin Connectors (polarity doesn't matter) and then push the Rocker Switch into the cutout.

Figure 11



Figure 9

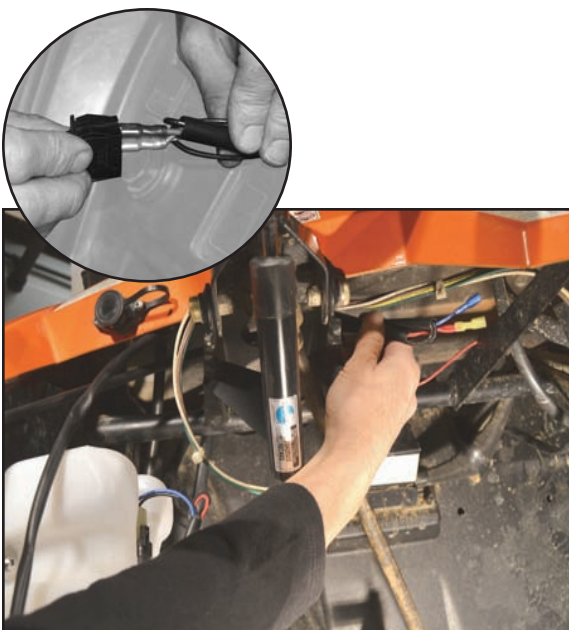

Figure 10



Figure 11



Figure 12

WIRE HARNESS INSTALLATION- BATTERY TERMINUS

1. Locate Battery terminus section (a) of the Wire Harness.

 For ease of routing, use a Zip-Tie (14) to temporarily secure the positive and negative ends together.

2. Route the Battery terminus end (a) over the steering column and through firewall (under hood compartment) by way of the hole in the upper area of fire wall.

Figure 12

3. From the front left wheel well, route the Battery terminus alongside the vehicle's main wiring harness through the console tunnel.

Figure 13 and 14

4. Continue to pull the Battery terminus section of the Wire Harness along the vehicle's main wiring harness to the battery compartment.

Figure 15

5. Loosen the negative terminal nut of the vehicle's battery with a Phillips screwdriver or an adjustable wrench. Slip the Brass Open Ring Connector under the negative terminal nut and tighten securely. Repeat for the positive terminal.

Figure 16 (Phillips Screwdriver)

SECURE WIRE HARNESS THROUGHOUT VEHICLE

Use the Zip-Ties (14) to coil and secure the Wire Harness properly within the vehicle, A-D below.

Do not leave loose Harness anywhere in the vehicle.

Once Zip-Tie is tight, clip excess off end. (Wire Cutters)

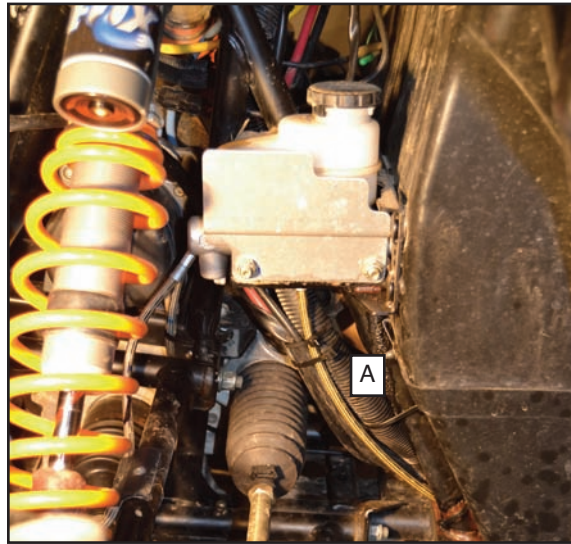

Figure 13



Figure 14

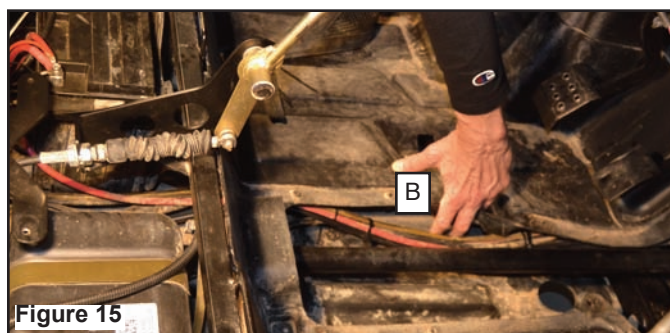

Figure 15

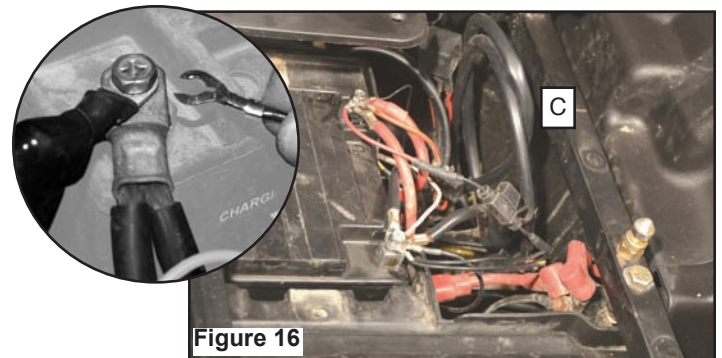

Figure 16

A. SECURE at three locations to vehicle's main wire group inside front compartment.

Figure 13

B. Tighten and SECURE at three locations to vehicle's wire group along center floor of vehicle. Stay away from the drive shaft.

Figure 15

C. Coil and SECURE excess inside battery compartment.

Figure 16

D. Coil and SECURE any excess from Harness sections (b, c, and d) inside the Driver's cab. Refer to pages 4 and 5. Secure Wire Harness routed over steering column. Secure loops of excess harness under dash, away from the foot well.



Figure 17

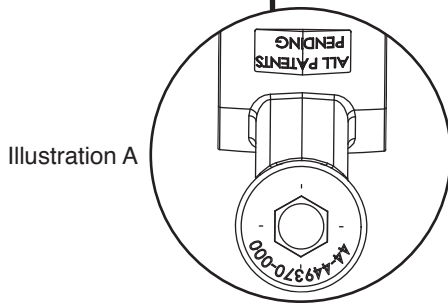

Illustration A

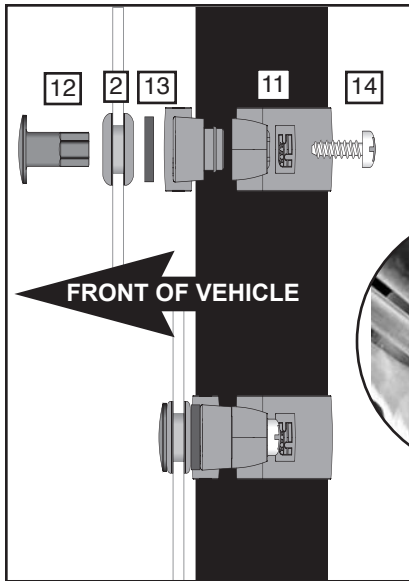
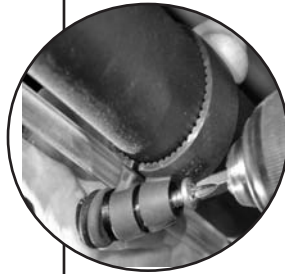

Illustration B

Perspective from bottom of top frame looking up, or outside of left frame.



WINDSHIELD INSTALLATION

Place fasteners within reach of assembling clamps.

1. Snap 3 Wraparound Clamps (10) on the top frame of the vehicle. Orient the top clamps facing down and male half (with embossed part number) toward the front of the vehicle.

Figure 17 and Illustration A

Read these helpful tips for a smooth installation:

Note the hex shape of Retainer Pin (11), and male Clamp (10) half.

While installing the windshield Clamps (10) in the next step, tuck Wire Harness between Clamp and Windshield.

Figure 18

Place Spacing Washer (12) between Grommets (2) and Clamps (10).

Start Machine Screws (13) but do not tighten.

The tabbed section of the Windshield should be touching the hood of the vehicle.

2. Place Windshield on hood, Using Screws (13) install top Clamps (10), but do not fully tighten.

Illustration B

(Phillips Screwdriver or Power Drill on low setting)

3. Snap the remaining 4 Wraparound Clamps (10) on the frame of the vehicle. Orient the clamps so that the male half (with embossed part number) is toward the front of the vehicle. Install Clamps, but do not fully tighten.

Figure 17 and Illustration B

(Phillips Screw Driver or Power Drill on low setting)

4. Check the alignment and position of the windshield and make sure it is even and symmetrical.



Figure 18

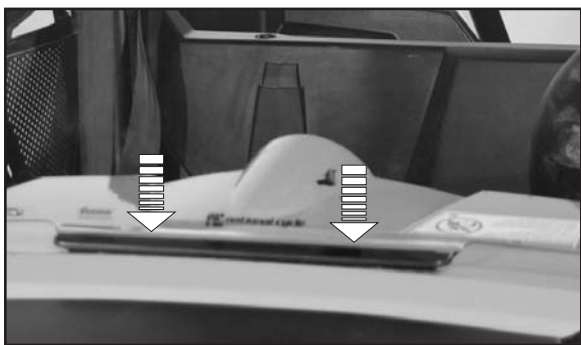

Figure 19

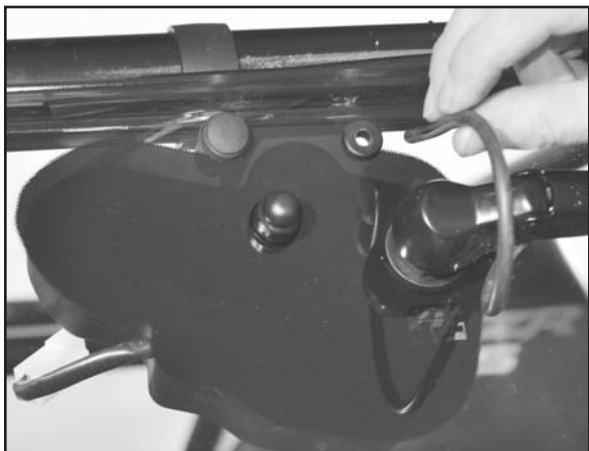

Figure 20

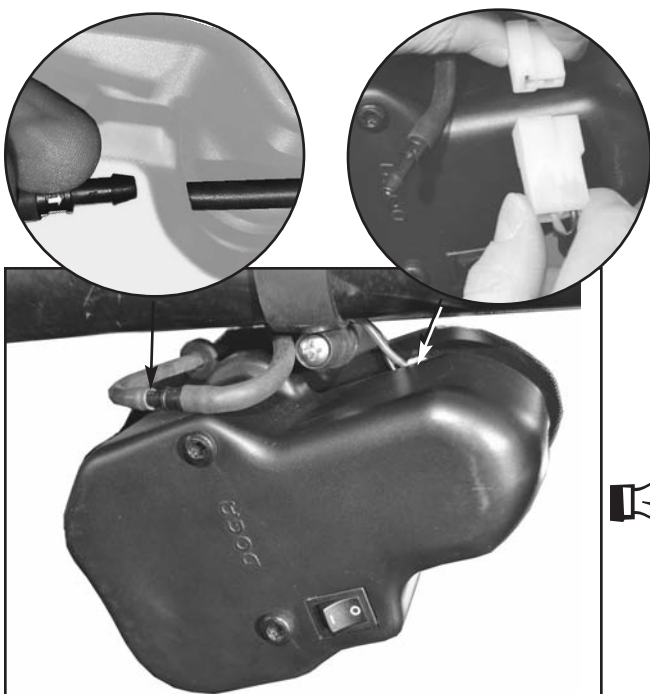

Figure 21

WINDSHIELD INSTALLATION, continued

5. Remove the adhesive backing from the Velcro loop material and then press the windshield tab firmly onto the hood of the vehicle.

Figure 19

FINAL TIGHTENING and REINSTALLATION OF PARTS REMOVED FROM VEHICLE

1. Securely tighten the Machine Screws (13) in all Wrap-around Clamps (10).
2. Check that the Wire Harness is coiled and secured.
3. Reinstall the center console and seats.

FINALIZE CONNECTIONS TO WIPER

1. Check that the Wiper Arm Fluid Hose is threaded through the Grommet in windshield. If it is not, do this now.

Figure 20

2. Connect the Wiper Motor Power and Fluid Hose.
Figure 21

A little moisture on the Fluid Hose end will make them join easier.

3. Tuck Motor Connector behind Motor assembly.
4. Completed Windshield Wiper Motor installation should appear as shown in Figure 21.

FILL THE FLUID RESERVOIR

1. Fill the Reservoir (9) inside the vehicle's cab with plain water during warm weather and glycol-based automotive windshield washer fluid in freezing weather.

2. DO NOT run the pump dry. Minimum amount of fluid to maintain in the Reservoir is:

12 oz. (.35L) or to a depth of 1 1/2" (38mm)

Minimum depth of 1 1/2" -----

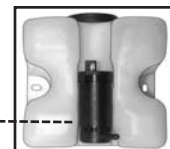

Please refer to page 9 and 10 for operation, replacement parts and warranty.

Enjoy Your New Wash'n'Wipe™ Windshield!



Figure 21



Figure 21

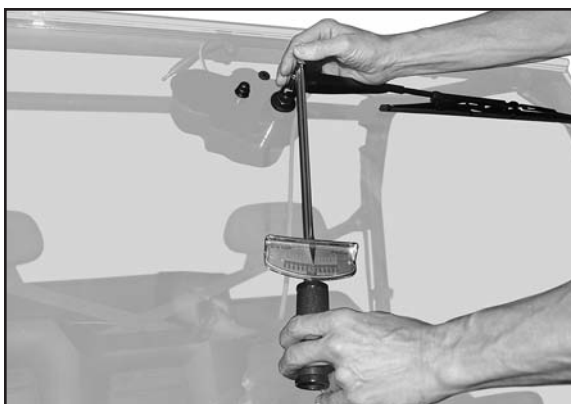

Figure 21



WINDSHIELD WIPER OPERATION



The Wiper is intended for use with the wash cycle or during rain. DO NOT Wipe a dry windshield.

DO NOT run the Pump without fluid.

The Wiper Motor has an on/off Rocker Switch as shown. Turn the switch on and verify that the Wiper works as expected.

The dash panel Rocker Switch installed controls the fluid spray. Momentarily hold the Switch in the on position to spray water from the Wiper Arm. It should spray in four separate directions.



The 4 spray jets can be redirected carefully.

WIPER ARM AND BLADE

Your Wash'n'Wipe Windshield is equipped with a quality silicone Wiper Blade. Replacement Wiper Blades are available from your local dealer or by contacting National Cycle.

Replacement Wiper Blade Part Number is N30900

Replacement Wiper Arm Part Number is N30910

REPLACING THE WIPER BLADE AND ARM

Open the small access cover on the Wiper Blade and pull the blade towards the motor end of Wiper Arm to loosen blade.

Join the end of the Wiper Arm (6) to the Wiper Blade (7). Place the J-hook of the Arm over the Blade's plastic mounting clip until it clicks and locks into place. Close the small access cover.

Figure 22

Swivel up the mount cover of the Wiper Arm as shown and then mount the Wiper Arm over the Motor's Spindle.

Figure 23

Once the Wiper Arm is on the Spindle, install the Internal Tooth Lock Washer and Small Mounting Nut. Use a torque wrench to tighten the Small Mounting Nut to 16 foot-pounds (22Nm). Then swivel the mount cover of the Wiper Arm back to its closed position.

Figure 24 (Torque Wrench)



CLEANING AND MAINTENANCE

To clean the screen, wash with a clean soft cloth, plenty of warm water and if necessary, a non-abrasive soap such as dishwashing liquid. Flannel or soft chamois make good cleaning cloths. **Paint, glue residue or grease removal:** Moisten cotton with naphtha or turpentine followed by a wash as above.

National Cycle **Shield Wash™** (N1401-01) makes a good daily cleaner and comes with a handy travel size bottle. Shield Wash is safe for all windshields and helmet visors.

Do not clean polycarbonate in hot sun or high temperatures. Do not clean the screen with glass cleaners.

Do not allow brake fluid, alcohol, or strong solvents to contact the screen.

RAIN REPELLENT

Do not use rain protective products made for glass. We recommend National Cycle's **RainZip®** (N1410-01) to help shed water in rainy weather.



Register your windshield online at www.nationalcycle.com

National Cycle's UTV Windshield 3-Year Limited Warranty

National Cycle hereby warrants to the original registered owner of a National Cycle polycarbonate windshield for a period of three years from the date of purchase against breakage. This limited warranty is expressly limited to the replacement of the polycarbonate windscreen. This limited warranty does not include scratches, coating failure, cosmetic wear and tear, replacement of hardware, or any consequential damages or expenses including

labor cost of installation, removal and/or replacement, inconvenience, inbound or replacement outbound freight expenses (outbound freight must be paid in advance by cc or check) or damage to any other component of the vehicle or any other accessories. Certain chemicals, generally known as acidic hydrocarbons, are known to cause polycarbonate damage and will not be covered under this limited warranty. Please refer to the cleaning instructions supplied with your UTV Windshield.

⚠ WARNING

Never operate your vehicle with loose accessory mounting hardware. Check the hardware for tightness regularly.

UTVs are built with enough frame rigidity to withstand the moderate loads imposed on them by the foreseeable addition of an accessory(ies). If an accessory(ies) adversely affects your vehicle's stability, immediately remove the accessory(ies). Do not operate a vehicle that exhibits unsafe handling traits.

Have experienced service personnel correct any problem before driving with the accessory(ies) installed. For further questions concerning handling problems associated with an accessory(ies), contact your dealer, UTV manufacturer, or accessory manufacturer.

CAUTION: Do not clean polycarbonate in hot sun or high temperatures. Do not clean the screen with glass cleaners. Certain chemicals, generally known as acidic hydrocarbons, are known to cause polycarbonate damage. Do not allow brake fluid, alcohol, or strong solvents to contact the screen.

CAUTION: Do not use rain protective products made for glass. We recommend National Cycle's **RainZip®** (N1410-01) to help shed water in rainy weather.

CAUTION: Always face windshield forward (in direction of travel) while carrying on truck or trailer.