



780 Professional Drive N. Shreveport, LA 71105 Phone (318)-524-2270 Fax (318)-524-2297
www.highlifter.com

Read before Installation

This product is designed for use on RUVs for **extreme mud riding conditions**. Purchasers should be aware that use of this product **will** increase the frequency of required maintenance, part wear, **will** raise the center of gravity on your RUV, will increase stopping distance, will decrease turning radius and will increase risk of roll-over, injury and death on all types of terrain.

It is your responsibility to always inform other operators and passengers of this vehicle and about the added risks.

Adding or modifying any OEM or aftermarket part will usually void factory warranty. This product could interfere with other aftermarket accessories. If the user has aftermarket products on machine, contact High Lifter Products to verify that they will work together. It is up to the end user or installer to verify this product works in conjunction with all other accessories installed. Adding aftermarket suspension components and/or more aggressive tires can cause breakage of other OEM driveline components such as differentials, axles or drive shafts.

We recommend that wider tires and/or wheel spacers be used to achieve a wider stance and to improve stability of the RUV. Riders should be advised that the handling characteristics of a taller ATV or RUV are different and require extra care when riding, particularly on side hills, off-camber situations, turning and stopping. If you further raise the center of gravity by adding taller tires, heavy loads, or by any other means, the RUV must be operated with even more care, at slower speeds and on relatively flat ground. All turns should be done at a slow speed, even on level ground.

Operation of an RUV with or without modified suspension components, while or shortly after consuming alcohol or drugs, subjects the rider to the risk of serious bodily harm or possible death. This risk is compounded if the rider does not wear an approved helmet and other safety gear. High Lifter urges that all approved safety gear be worn when riding an RUV as a driver or passenger.

By purchasing and installing this product, user agrees that should damages occur, High Lifter Products will not be held responsible for loss of time, use, labor fees, replacement parts, or freight charges. High Lifter Products will not be held responsible for any direct, indirect, incidental, special, or consequential damages that result from any product purchased from High Lifter Products. The total liability of seller to user for all damages, losses, and causes of action, shall not exceed the total purchase price paid for the product that gives rise to the claim. **Since this is an extreme product, the manufacturer specifically disclaims any liability for consequential damages or accidents injuries, or death, in connections with the use of this product.**

If this product is not what you expected, or is not consistent with your intended use, you should return the product immediately to the seller, before installation, for a refund of the purchase price; less any fees. After installation, product is warranted to the original user and vehicle for the life of that vehicle for defects in workmanship and materials. Axles have a one year warranty for one break. Additional breaks will be charged a repair fee depending on the problem. High Lifter Products will warranty only parts provided by High Lifter Products. Any damage or problems with OEM housings, bearings, seals, or other manufacturer's products will not be covered by High Lifter Products. Parts and products will not be warranted if item was not installed properly, misused, or modified.

Dealers and other Installers

You are responsible for informing your customer and end user of the information contained above and the increased potential hazards of operating an RUV equipped with modified suspension components. If you install any suspension modifying components, it is your responsibility to also install the warning label prominently in view of the driver and passenger. They should also be instructed to notify anyone operating the vehicle, as well as any passengers, that said vehicle is modified.

As discussed above, it is critically important that they be instructed in the need for slower speed operation, regardless of terrain, after this kit is installed.

Parts Diagrams

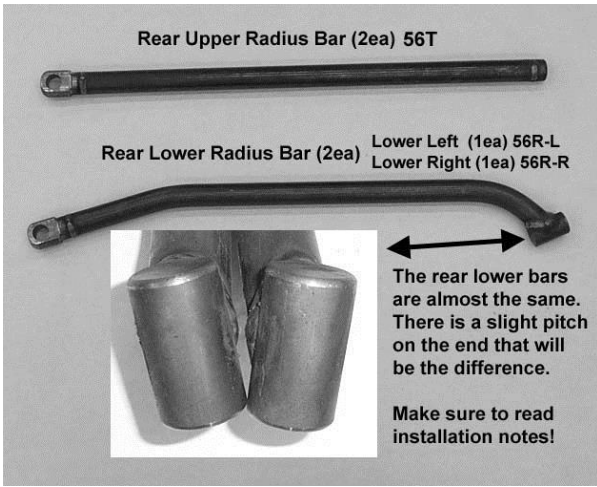
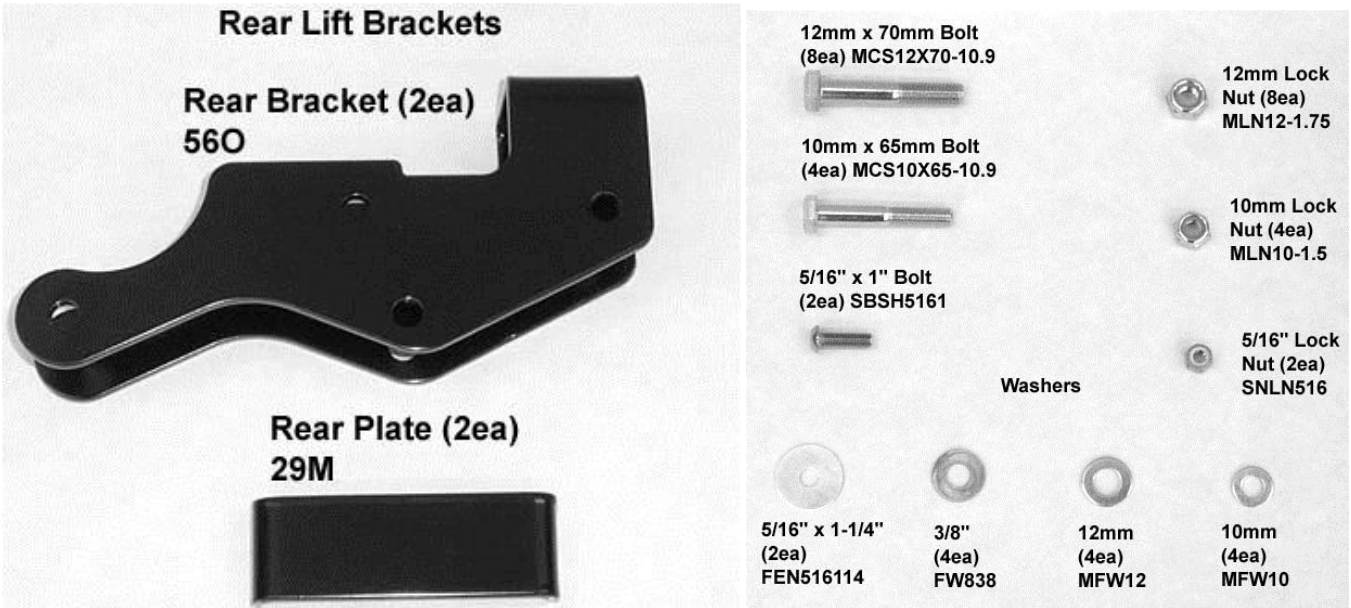
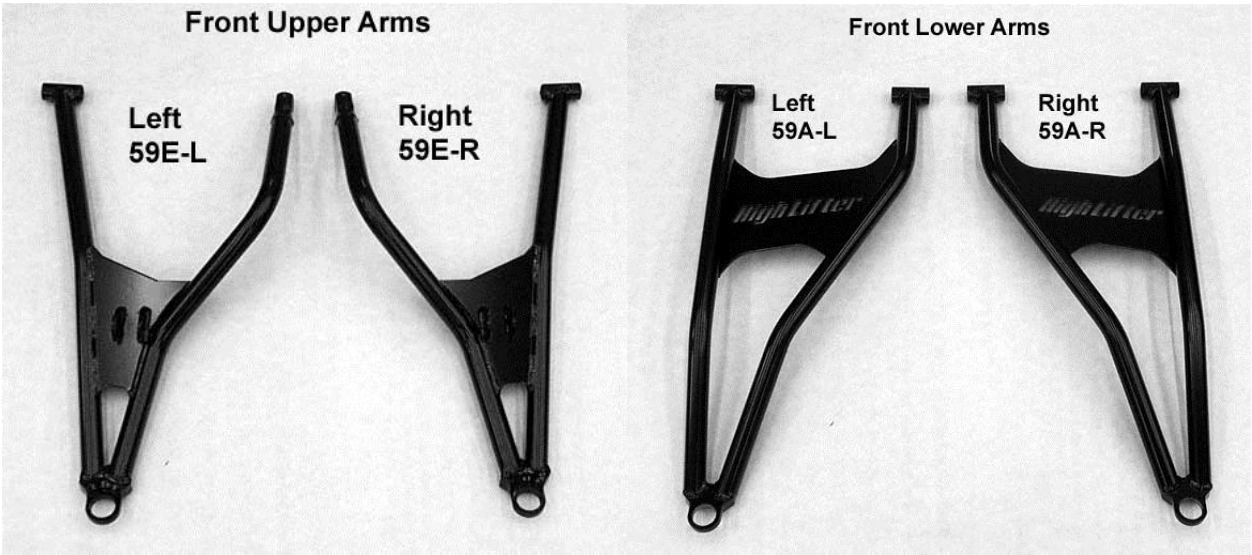

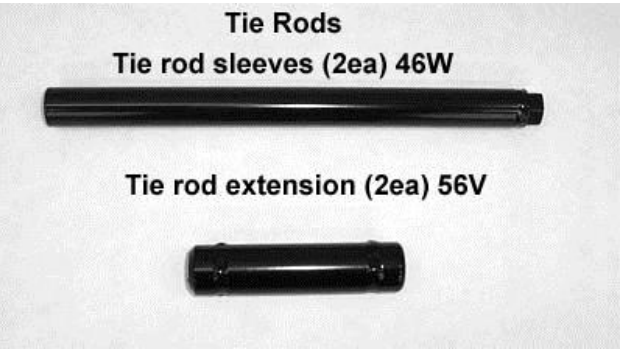
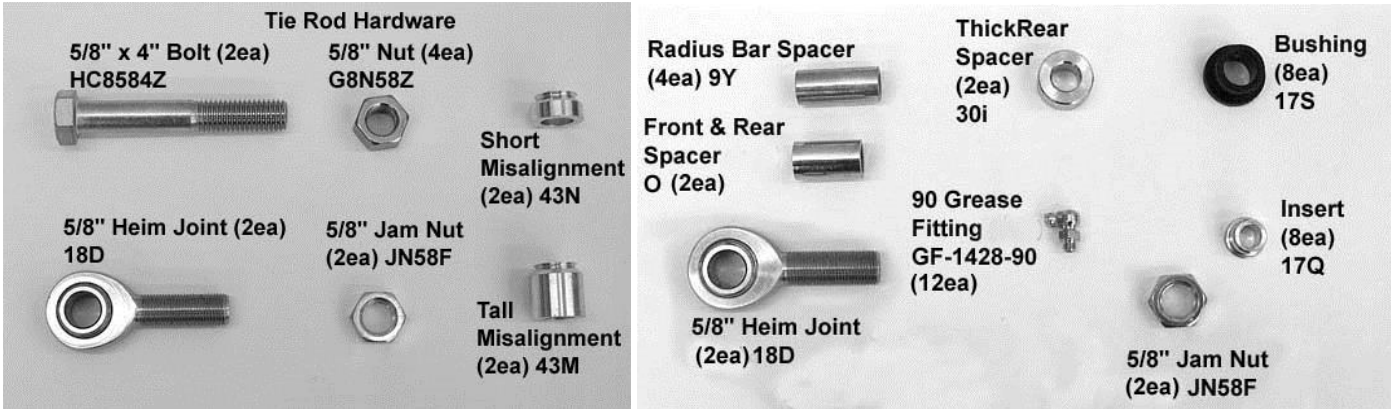
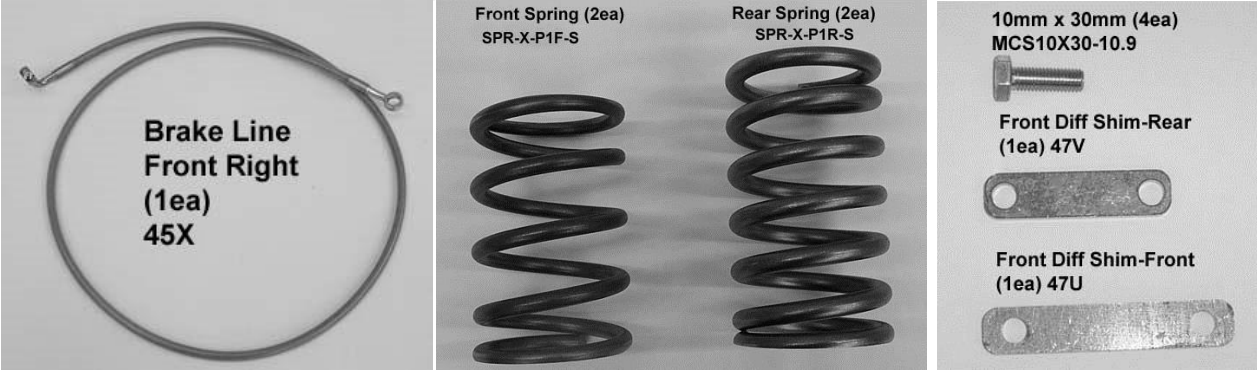
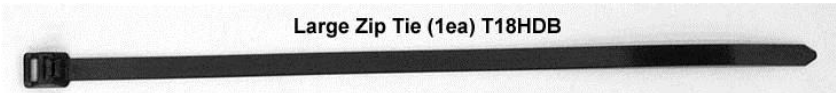
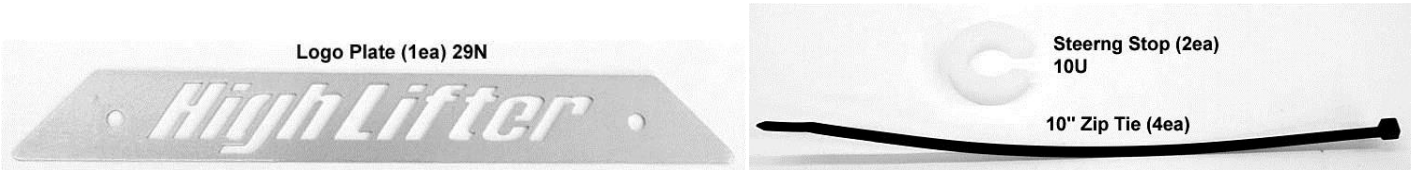

NOTE: There are four axles not represented; front axles RCV-X-RZR9S-F (2ea) & rear axles RCV-X-RZR1-2-R (2ea)

Installation Instructions

When referring to left and right positions during the installation process, it is from the seated position!

1. Place the jack under the center of the RZR front end and lift until the front wheels clear the ground. Be careful to support the RZR properly so that it is secure, but so that the A-arms and shocks can droop to full extension.
NOTE: Make sure that the jack is tall enough to raise the ATV high enough to reinstall the tires after the lift is put on.
2. Remove the front wheels and shocks.
3. Disconnect the calipers from the knuckles and the brake lines from the A-arms. Push the calipers aside so that they do not interfere with removing the remaining factory components.
4. Next you will need to disconnect the tie rod from the knuckle assembly.
5. Remove the cotter pin and castle nut that secures the axles to the knuckle assembly.
6. Now disconnect the knuckle assembly from the upper and lower control arms. It should slide away from the axle.
7. Now pull the axle out of the differential. You may need to tug hard on the axle to pop it out of the differential.



8. Disconnect the upper and lower control arms from the frame. Do this on both sides.
9. Because the kit comes with replacement axles that have very large axle bars, these bars will hit the frame when installed. You will need to shim up the differential to gain the clearance needed to install the new bars.
10. There is a roll/spring pin that connects the differential to the drive shaft. You need to push out the roll/spring pin so that you can disconnect the differential from the drive shaft.

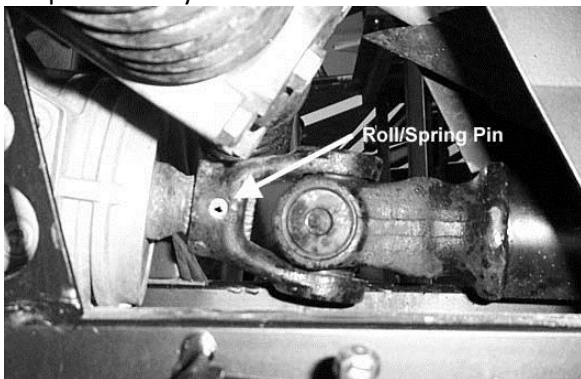

11. Disconnect the wires and vent line from the differential.



12. Remove the 4 bolts that secure the differential to the frame.

13. Remove the front differential.



14. Once you have removed the differential, you will need to clearance the rack and pinion and also trim the differential.

15. First clearance the rack and pinion. Review the photos to see the areas that will need to be trimmed.

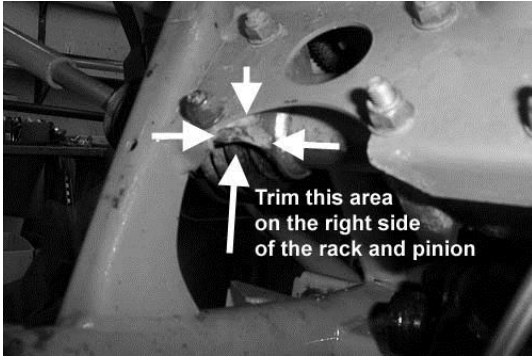

16. Next you will need to remove some of the material on the differential. Just enough so that it does not hit the frame when you install the shims.

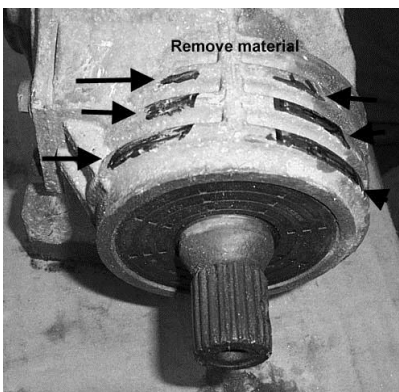
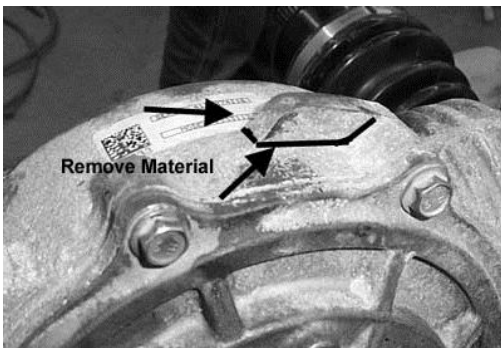

NOTE: You will need to test the differential in place to see if you have removed enough material. So don't secure the driveshaft to the differential until you have installed the shims and check for clearance.

17. When you have achieved the proper clearances you need to secure the differential to the frame.

18. Install the differential in place by first making sure that the roll/spring pin holes line up in the drive shaft yolk and shaft on differential. Once they are aligned insert pin.

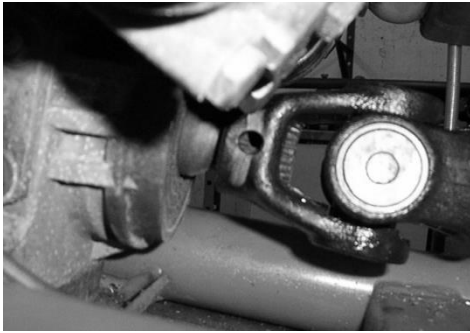

19. Insert the two differential shims in place under the differential. The longer shim goes to the front of the differential and the shorter goes to the rear of the differential.

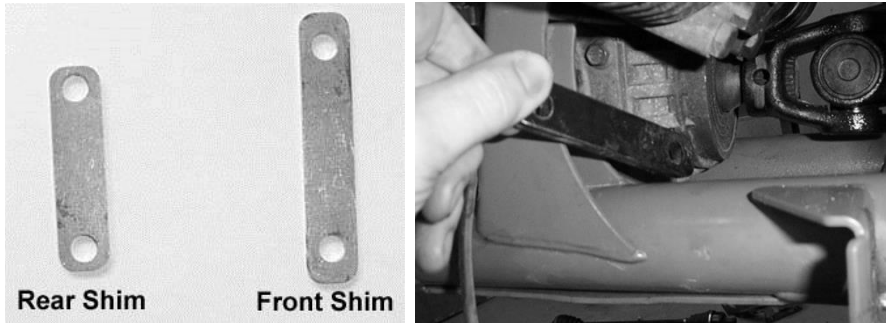

20. Once you have them under the differential, use a small punch or screwdriver to align the holes in the shims with the holes in the differential. **This is difficult!**



21. Secure the differential in place with four 10mm x 30mm bolts and 10mm washers.

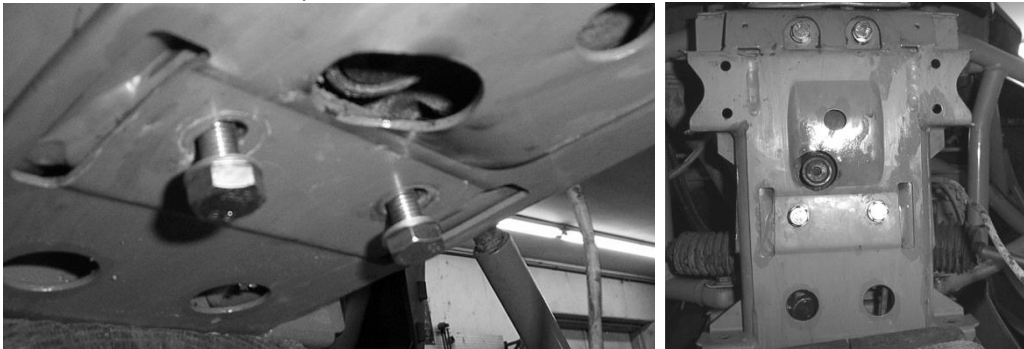

22. Reconnect wires and vent lines to the differential.

23. Before you proceed with the installation of the lift kit and new control arms, you will need to disconnect the brake lines from the master cylinder. You are going to take the factory brake line on the right side of the RZR and install it on the left side. The new 45X brake line will be attached on the right side of the RZR.



24. Disconnect and remove the right side brake line from the master cylinder and replace it with the new line provided. Now install the right side factory brake line on the left. When you have installed the front arms you will need to route brake lines to the front of the new a-arms. This will ensure that you have no binding or pinching of the brake lines.

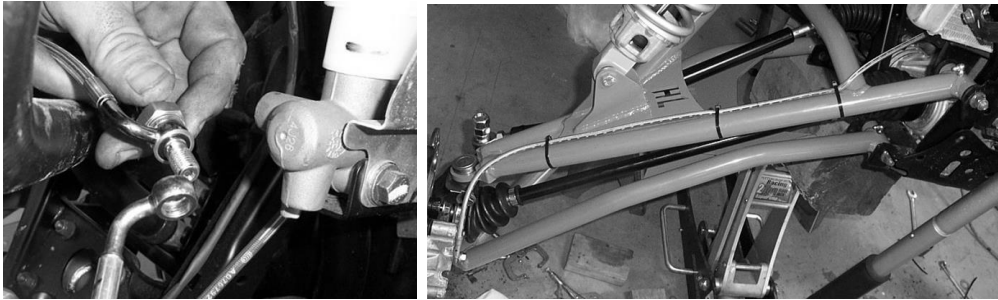

25. When you have completed the brake line installation, reconnect the lines to the calipers. Use the factory hardware to reconnect all lines.
26. The next few steps will be to prepare for the front upper and lower control arm installation.
27. Remove the bushings, sleeves, and ball joints from the stock control arms. You will need to reuse these in the new kit.

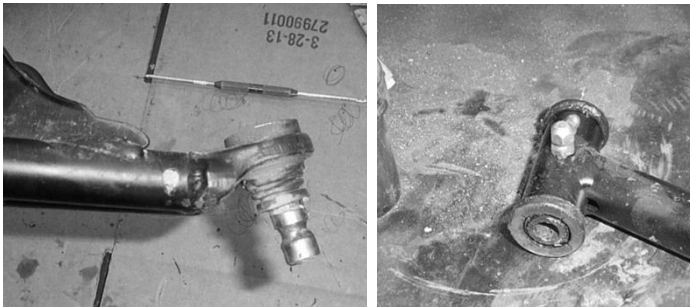

28. Now reinstall the bushings, sleeves, and ball joints into the new arms. If you place some grease on them it makes the installations easier.

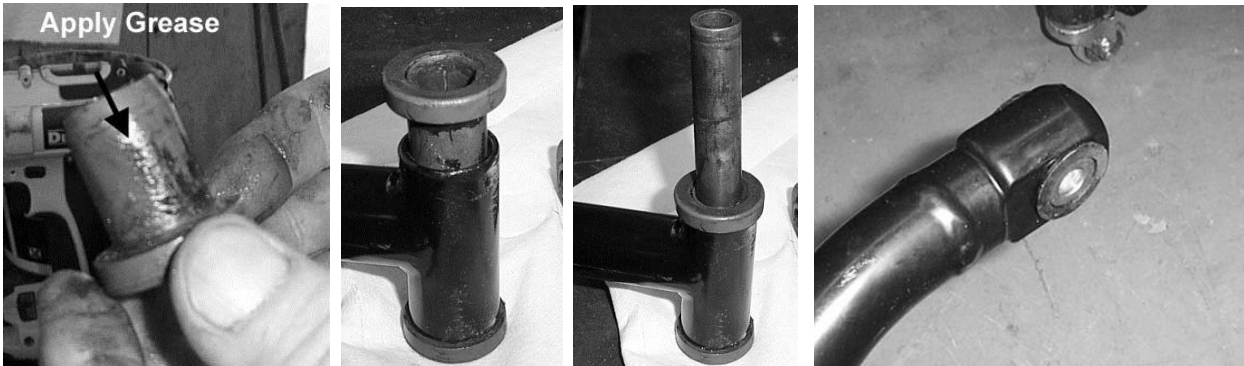

NOTE: A press or a vise is suggested for removing and replacing the ball joints. If you press in the ball joint crooked, DO NOT TRY TO FORCE IT IN! If you try to force it straight you can “egg” the opening. Press the ball joint out and reinsert it into the opening, pressing it in with a vise. Verify that the clip snaps into place after installing the ball joints into the new Control Arm. You should always double check the ball joint snap ring for proper fit. Even if you use snap ring pliers, it may not seat. You can use a flathead screwdriver and a hammer to tap the snap ring to ensure that it is seated into the groove.



29. Install the grease fitting into the new arms before installation. **DO NOT OVER TORQUE THE FITTINGS.**



30. Set all control arms aside at this time.

31. For ease of installation you will need to install the steering stops and tie rods at this time.

32. Start with the driver's side as this has the least amount of room to get your hands in and once you install the spacer on the passenger side you will have less play on the driver's side.

33. Turn the steering wheel all the way to the right. If you are working on the passenger side turn it all the way to the left.

NOTE: In order to re-secure the boot you will need to turn the steering wheel closer to the center to give you some play in the boot.

34. The boots on the rack and pinion are held on by zip ties. You will need to cut the zip tie that secures the boots to the inside of the rack and pinion.

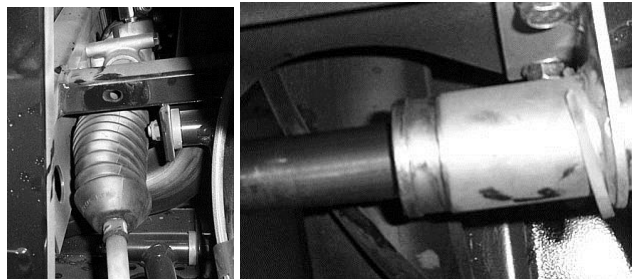

35. Next pull the boot back to expose the inner tie rod joint.

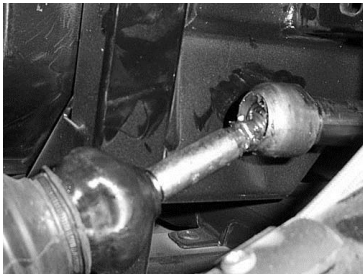

(This view is the passenger side)

Note: On the driver's side there is already a white spacer in place on the rack and pinion from the factory. You will add the new steering stop to it. DO NOT REMOVE THE FACTORY SPACER!



(Driver side view)

36. Place the steering stop clip between the inner tie rod joint and the rack and pinion. It is a tight fit, so you may have to force it on this is to ensure that the spacer stays in place.

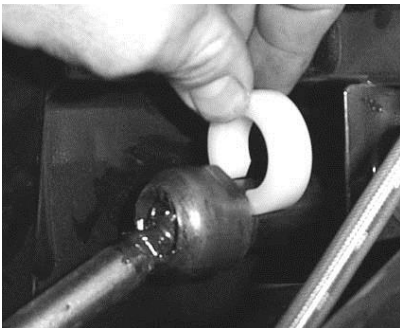

37. Pull boot back over the ball joint and steering stop and refasten with zip tie. Be sure to verify the zip tie is tight so to prevent material from getting into the boot.

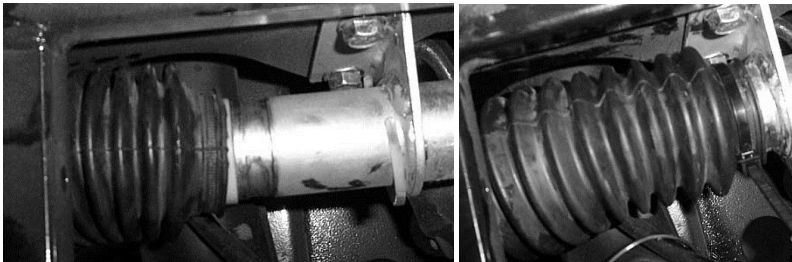

38. Once you have completed the steering stop installation you will need to connect the tie rod assembly.

39. Slide the new tie rod over the factory tie, screwing into place.

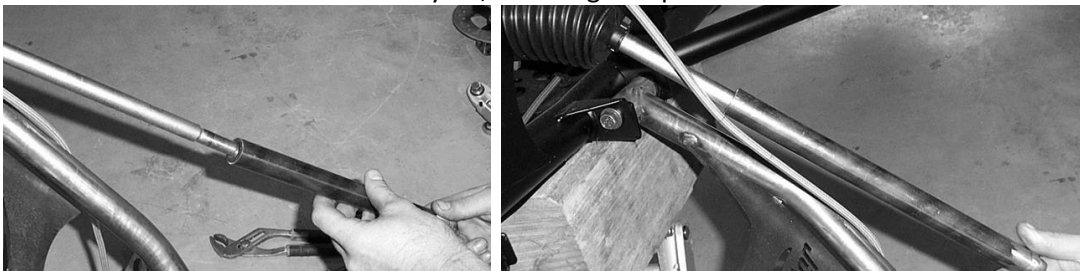

40. Next connect the smaller tie rod to the end of factory rod.

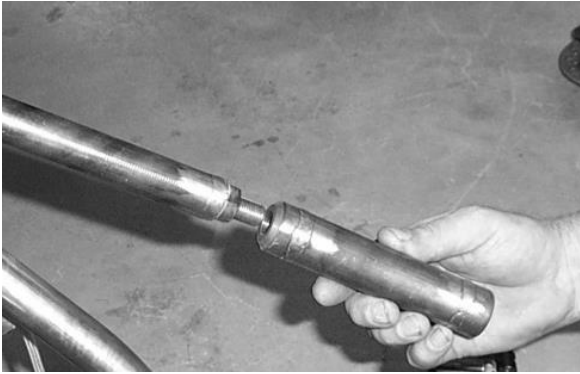

41. Get the 5/8" heim joint provided in the kit and place a 5/8" jam nut on the heim joint end. Run the jam nut all the way down to the bottom of the thread.



42. Screw the heim joint into the tie rod end. Repeat these steps for the opposite side.

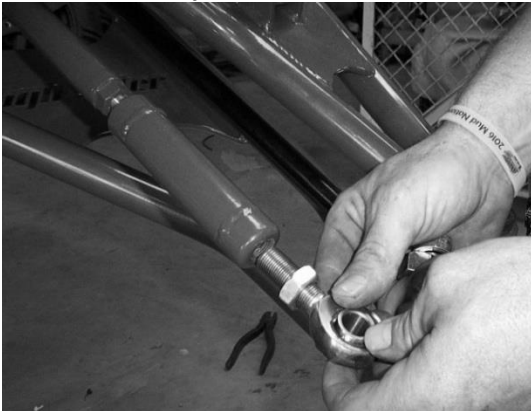

43. At this point you will need to attach the upper and lower control arms.

44. Use the factory nuts and bolts to connect the new control arms to the RUV frame. You will have left and right upper and lower control arms.



45. Install the new axles provided in the kit. Place some grease on the ends of the axles to make installation easier.

46. Reconnect the knuckle assembly, make sure to insert the new axle end into the knuckle assembly.
NOTE: Insert ALL ball joint connecting bolts from rear to front! If this is not done the control arm will rub on the bolt at full steering lock.

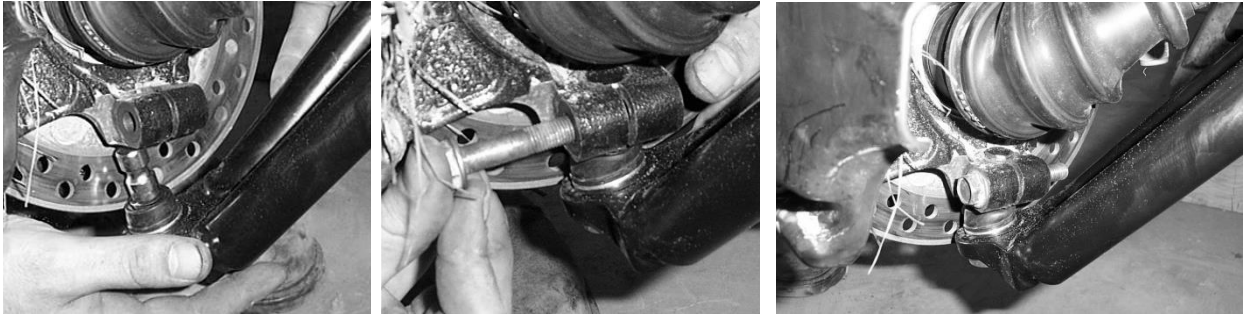

47. Included in the kit are new axle washers and a new crimp nut. You need to use two washers per axle. Fasten the axle to the hub assembly with the new crimp nut, using a punch to lock the axle nut in place.



48. Finish connecting the tie rod to the knuckle assembly by using the 5/8" x 4" bolt, long and short high misalignment cones, and two 5/8" nuts.
49. Where the original tie rod connected to the knuckle assembly you will need to drill out a 5/8" hole.



50. Once you have drilled the hole insert the bolt up from the bottom of the knuckle assembly through the hole.

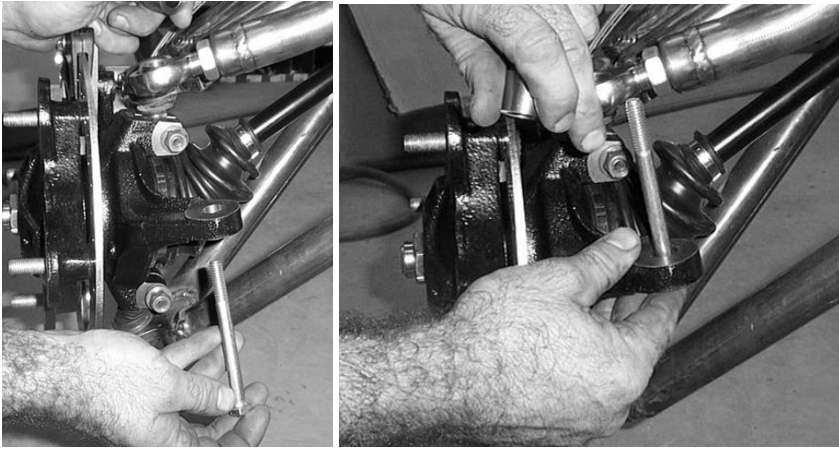

51. Place on the bolt the long high misalignment cone.

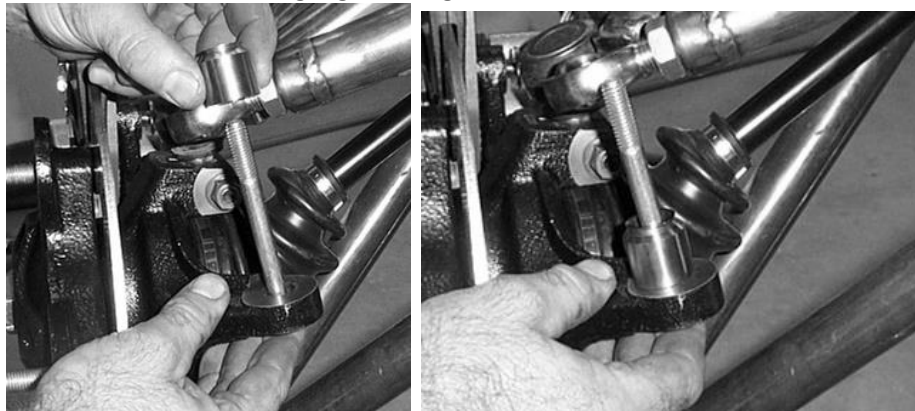

52. Now place the 5/8" heim joint on the rod end onto the bolt.

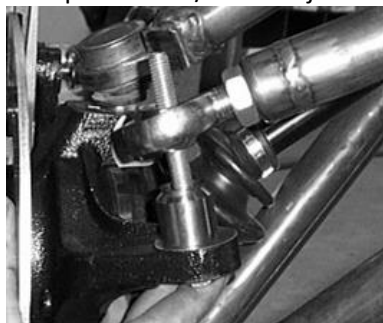

53. Place the short high misalignment onto the bolt.

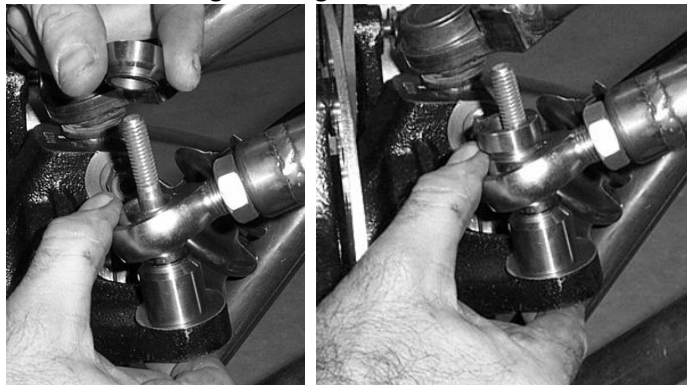

54. Secure the rod assembly using two 5/8" nuts.

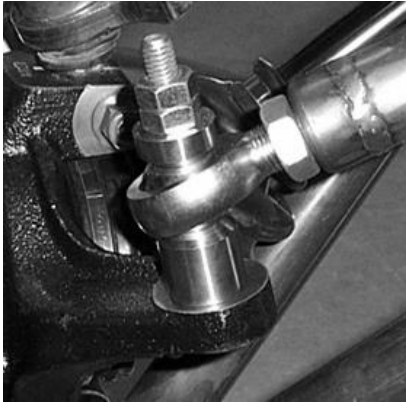

55. For the next steps you will need a spring compressor or a way to compress the factory spring.

56. Before you compress the spring on the shock you will need to adjust the tension on the shock to the lowest setting or to where the spring has the least amount of tension on it. You do this by adjusting the collar all the way down towards the shock eyelet.

NOTE VERY IMPORTANT: In order to keep from damaging the shock threads and spring adjuster you need to make sure that the threads are clean from dirt. The threads on the shock are easily damaged!!!

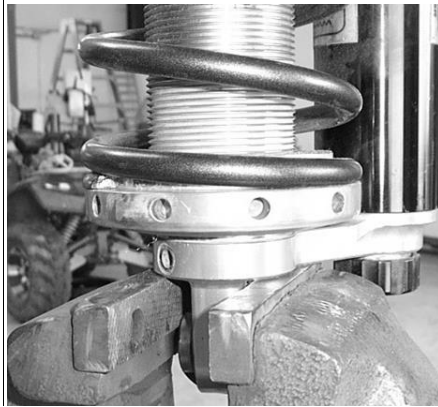

57. Compress the spring and remove the retaining collar from the shock.



58. Now remove the spring and center spring collar.

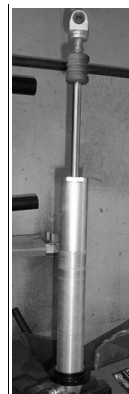

59. There are two different springs for this kit. There is a 6" tall spring with a 300 rating for the front and there is a 7" tall spring with a 400 rating for the rear. Install the 6" spring at this time. You will follow the same steps for the rear using the 7" spring.
60. Place the new spring onto the shock, (6" front & 7" rear).



61. Reinstall the center spring collar and spring. Compress the spring and reattach the spring retaining collar.



62. Reconnect the top of the shock to the frame using the factory hardware.
63. Connect the bottom of the shock to the new control arms by using the 10mm x 60mm bolts and 10mm lock nuts provided in the kit. Repeat the steps for opposite side.
64. Once you have completed the installation you will need to bleed the brake lines. Follow the steps listed below.
65. When you have completed the brake line bleeding process, place the wheels back on the RZR and torque lugs to factory specifications.

Brake Line Bleeding

Attach the 1 man bleeder bottle, or slip a small hose/tube over the end of the bleed screw and place the other end in a bottle/jar with a little brake fluid in it. That way as air bubbles out it can't return air back up the hose. The only thing being sucked up the hose will be brake fluid.

With the hose in place, open the bleed screw.

Being careful not to splash brake fluid everywhere, or to let the master cylinder go dry (therefore letting air back into the top of the system) depress the brake lever to force clean brake fluid into the brake line from the master cylinder. Do this 5-6 times and refill the master cylinder. You will find that you have to refill the master cylinder often as these are long brake lines and small master cylinders.

NOTE: Make sure that the cover to the master cylinder is on before you start pumping the brakes!!!

When you are confident that all the old fluid and air is purged from the line, close the bleed screw and move on.

After both front wheel calipers are bled, recap the master cylinder. You should now have good stiff brake pedal. It will probably take a whole pint sized bottle to do both front wheel calipers. Don't try to save the extra fluid and dispose of used fluid properly.

Master Cylinder/Brake Fluid

An over-full master cylinder may cause brake drag or brake lock-up, which could result in an accident. Maintain brake fluid at the recommended level. Do not overfill. Never store or use a partial bottle of brake fluid. Brake fluid is hygroscopic, meaning it rapidly absorbs moisture from the air. The moisture causes the boiling temperature of the brake fluid to drop, which can lead to early brake fade and the possibility of brake failure, which could result in an accident. After opening a bottle of brake fluid, always discard any unused portion.

Check the brake fluid in the master cylinder before each ride.

1. Position the unit on a level surface.
2. Position the handlebars so the master cylinder is level.
3. View the brake fluid level through the indicator window on the top of the master cylinder.
4. If the fluid level is low, remove the cover and add fluid to the fill line.

Do not overfill. Use DOT 4 brake fluid only.

5. Reinstall the cover.

Rear Installation

When referring to left and right positions during the installation process, it is from the seated position!

1. Place the jack under the center of the RZR rear end and lift until the rear wheels clear the ground. Be careful to support the RZR properly so that it is secure, but so that the trailing arms and shocks can droop to full extension.

NOTE: Make sure that the jack is tall enough to raise the RZR high enough to reinstall the tires after the lift is put on.

2. You will need to completely remove the rear shocks, rear radius bars, and disconnect the rear plastic from the frame so that you can lift it to install the upper lift brackets.
3. Before you jack up the UTV make sure to disconnect the rear sway bar from the arms. This will make installation easier

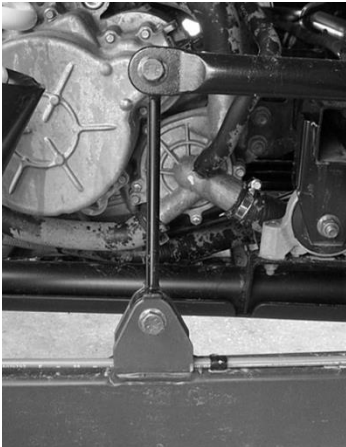

4. Next, jack up the rear of the UTV, securing it properly so that it does not fall, but it allows the arms to drop to full extension. Remove rear factory tires.
5. Disconnect the caliper/knuckle/hub assembly and radius bars from the factory trailing arms.

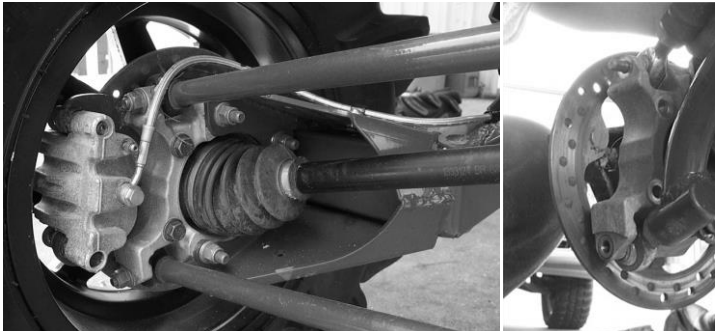

6. Next, completely disconnect the shocks from the trailing arm shock mount point and from the upper portion of the frame. You will need to remove the shock dust shield from the shock.



7. Disconnect the rear stock upper and lower radius rods from the frame.



8. Remove the factory axles from the differential by giving them a hard tug.
9. Remove both rear plastic fenders, Roll cage bars and shock reservoirs. **(The shock reservoirs only apply to NON-HLP Editions)** Remove all screws holding the plastic behind the seats too!

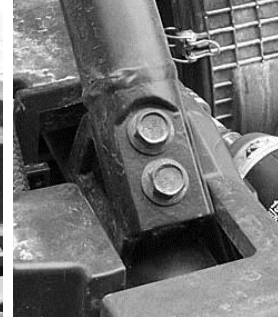
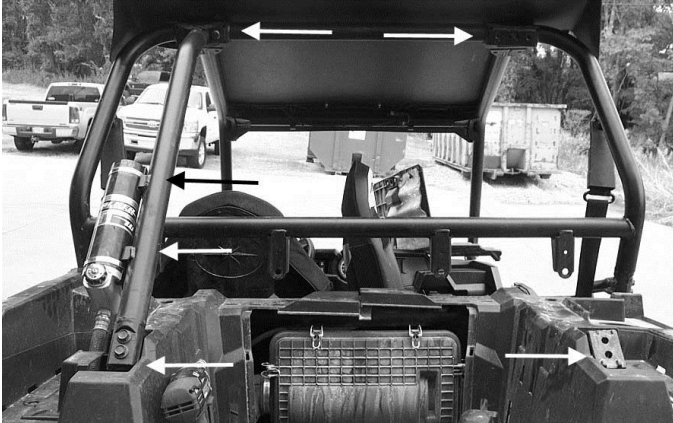

10. You may need to remove the air intake hose for clearance while installing the lift brackets.



11. Disconnect the top of the rear shock from the shock tabs if you have not done so already.
NOTE: When you reconnect the top of the shock to the lift bracket, you may need to compress the eyelet to allow it to fit into the bracket with the spacer.

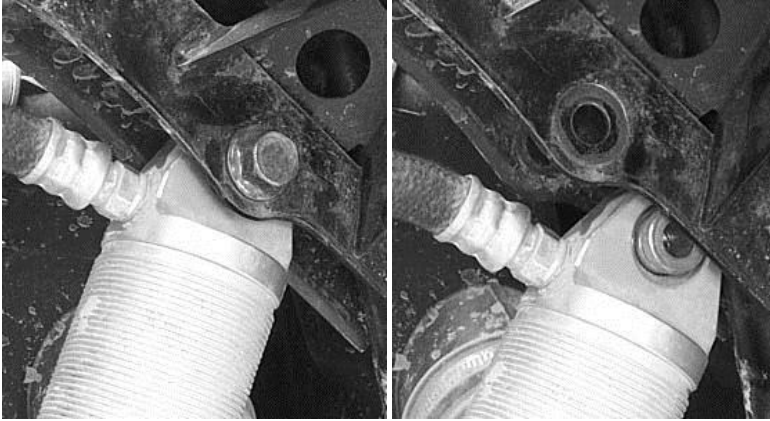

12. There is a support bracket that needs to be unbolted to allow for the lift bracket to slide into place. Unbolt bracket, slid the lift bracket into place then reattach the factory bracket.

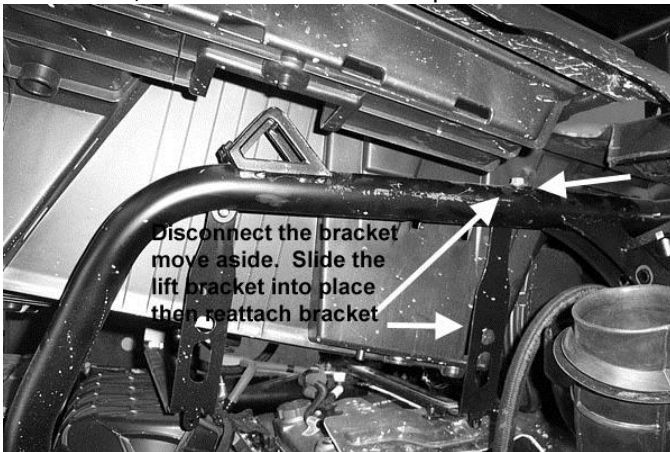

13. Insert the rear lift bracket through the plastic onto the frame.



14. Once you have the bracket in place connect it to the stock shock mounting tabs using the 12x70mm bolt and 12mm washer provided in the kit. Make sure that you insert the 12mm washer between the shock mounting tab and the bracket. (NOTE: In some of the images we have completely removed the plastic to better illustrate the steps)

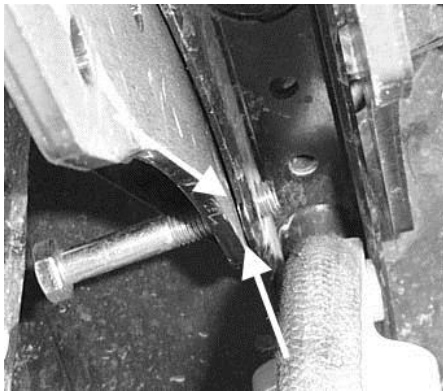
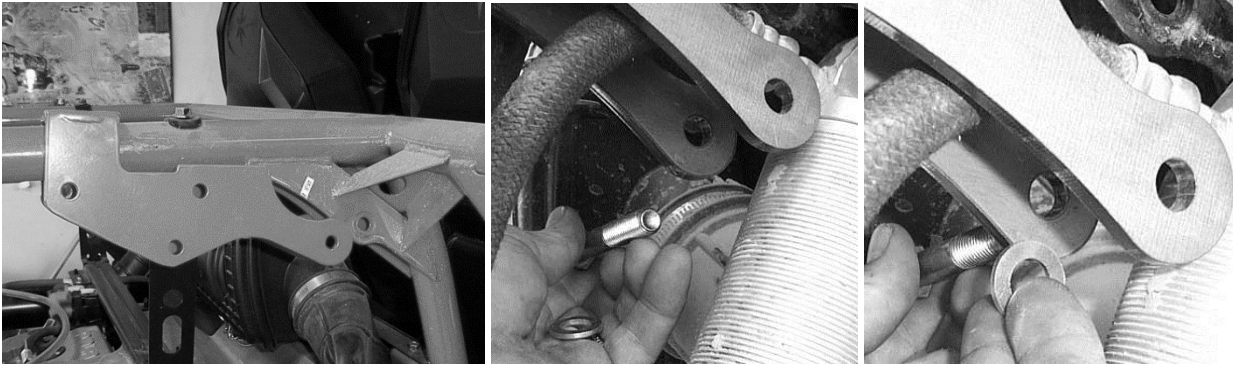

15. Next, place a spacer where between the shock mount tabs. Then, insert another 12mm washer between the shock tab and the bracket.

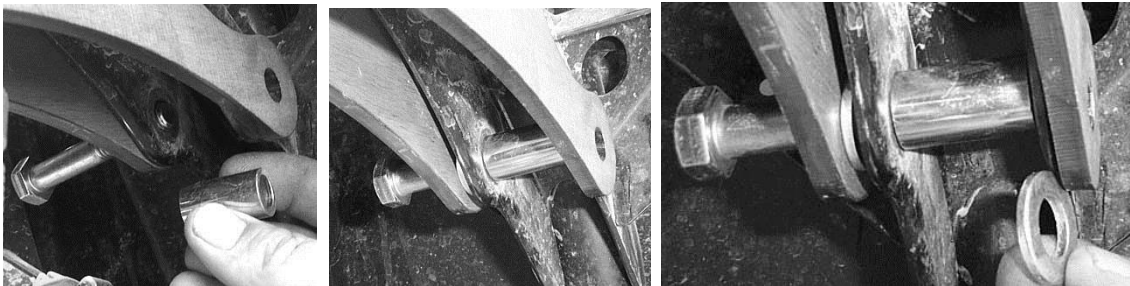

16. Push the bolt completely through, but you do not need to attach the 12mm lock nut at this time.

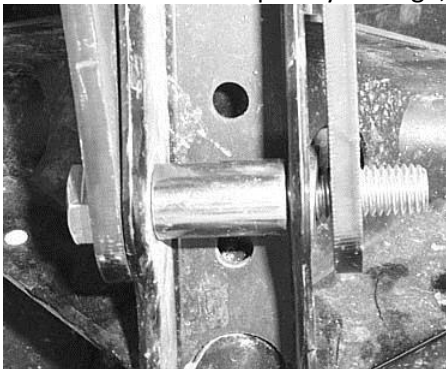

17. Next you need to attach the rear lift plate. Insert a 12x70mm hex bolt through the bracket.

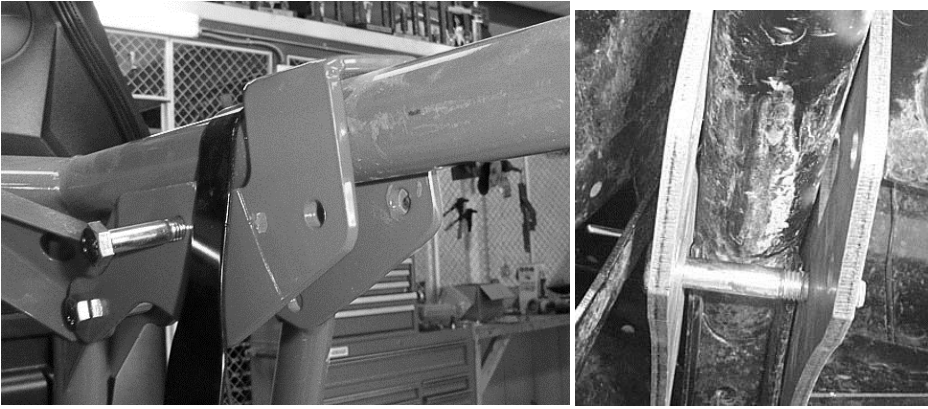

18. Insert the rear lift plate into the lift bracket and hook the bolt.

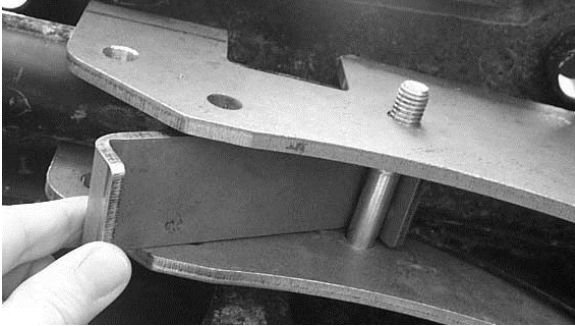

19. Push the rear lift plate all the way up touching the frame and insert a 12x70mm hex bolt.

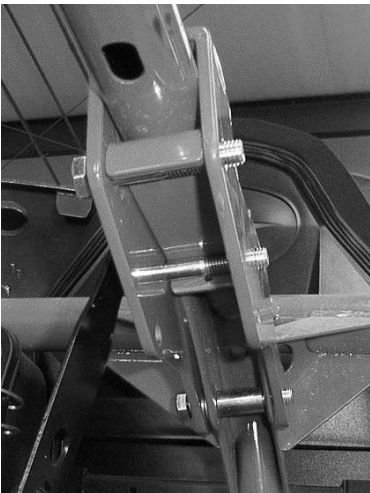
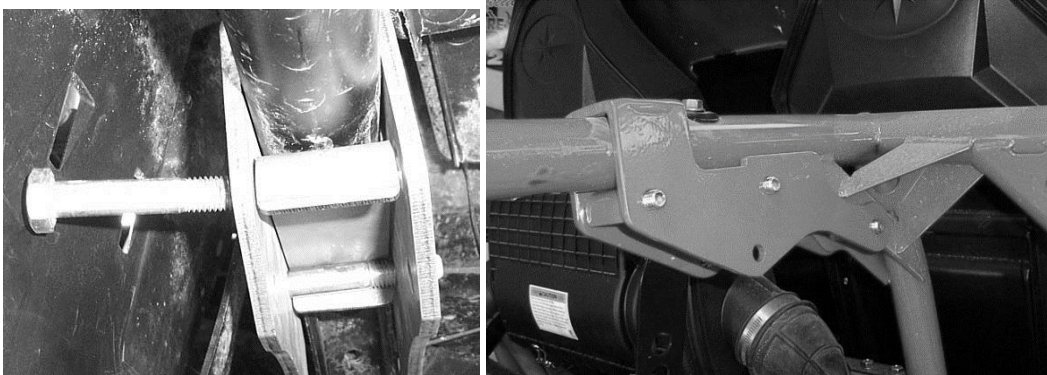

20. Now loosely attach the 12mm lock nuts to all bolts.

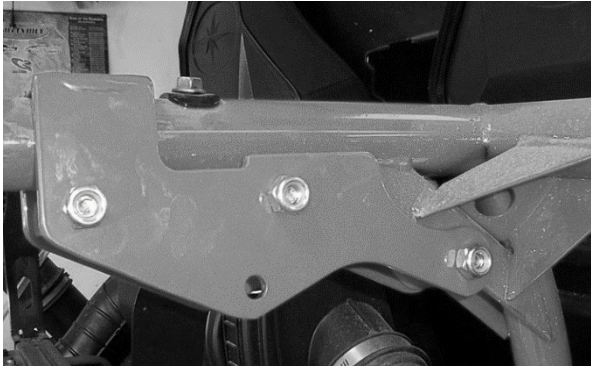

21. For the next steps you will need a spring compressor or a way to compress the factory spring. Use the same steps as you did for the front.

22. Before you compress the spring on the shock you will need to adjust the tension on the shock to the lowest setting or to where the spring has the least amount of tension on it. You do this by adjusting the collar all the way down towards the shock eyelet.

NOTE VERY IMPORTANT: In order to keep from damaging the shock threads and spring adjuster you need to make sure that the threads are clean from dirt. The threads on the shock are easily damaged!!!



23. Compress the spring and remove the retaining collar from the shock.



24. Now remove the spring and center spring collar.

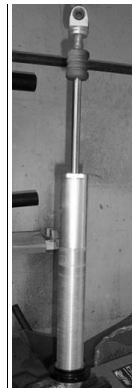

25. There are two different springs for this kit. There is a 6" tall spring with a 300 rating for the front and there is a 7" tall spring with a 400 rating for the rear. Install the 6" spring at this time. You will follow the same steps for the rear using the 7" spring.

26. Place the new spring onto the shock, (6" front & 7" rear).



27. Reinstall the center spring collar and spring. Compress the spring and reattach the spring retaining collar.



28. Now connect the top of the shock to the lift brackets by inserting another 12x70mm bolt through the bracket. Insert the rear shock spacer between the shock eyelet and bracket. Fasten tight using a 12mm lock nut.

Note: You may need to compress the shock eyelet to allow the shock and spacer to fit in between the bracket.

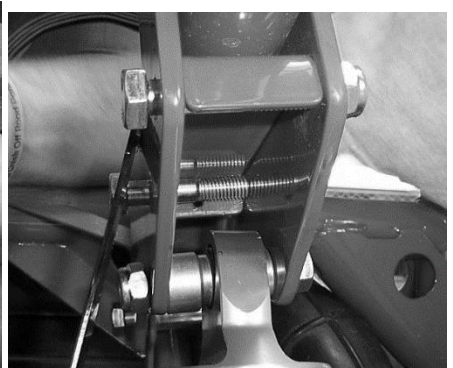
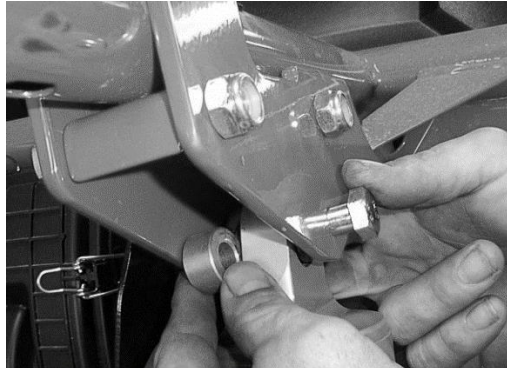

29. Reattach plastic fenders, Roll cage bars and shock reservoirs. **(The shock reservoirs only apply to NON-HLP Editions)** Reattach all screws holding the rear plastic behind the seats too!
30. Insert the new rear axles into the differential at this time. You need to put a little axle grease on the axle ends to make the installation easier.
31. Attach the new rear upper and lower radius bars.

NOTE: There are LEFT and RIGHT Lower Radius Bars!! On the end of the lower bar where the heim joint connects will have a slight turn on it. When mounted on the RZR they need to be mounted with the turn pointing towards the front of the RZR.
32. You need to preassemble the new bars. Insert the two black rubber bushings into open end of the radius bar. Make sure to add a little grease to the bushings, this will make the installation easier.



33. Next insert one sleeve in to the bushings.

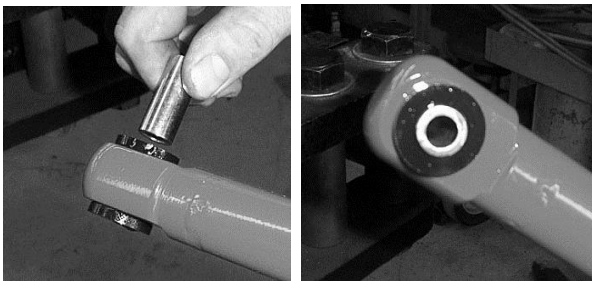

34. Now thread the jam nut onto the heim joint. Run it all the way down to the bottom of the threads and screw the heim joint into the radius bar



35. Insert the two heim adapters into the eyelet of the heim joint.



36. Attach the ends of the radius bars to the RZR frame using the 10x65mm Hex Bolts, 3/8" Flat Washer provided and the stock flat washer, and 10mm Lock Nuts provided in the kit.



37. Connect the shock to the trailing arm using the factory bolt and lock nut.

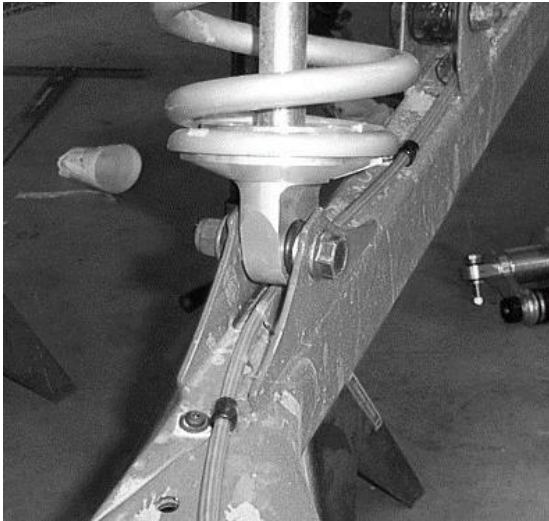

38. Insert the new axles into the rear differential.

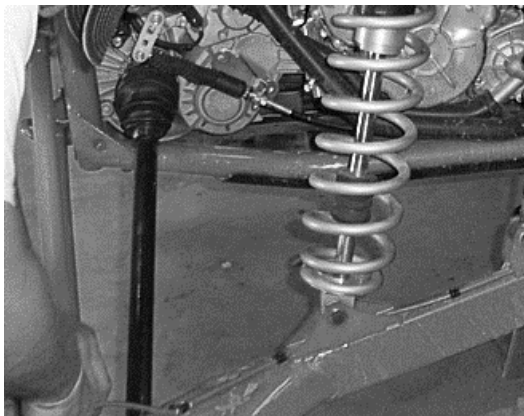

39. Remove the hub assembly from the trailing arm. Make sure to save the hardware because you will reuse it!



40. Connect the trailing arm adapter plate to the trailing arm. This adapter plate is a wedge shape. It will go between the trailing arm and hub assembly. Use the factory hardware to secure the hub to the trailing arm.

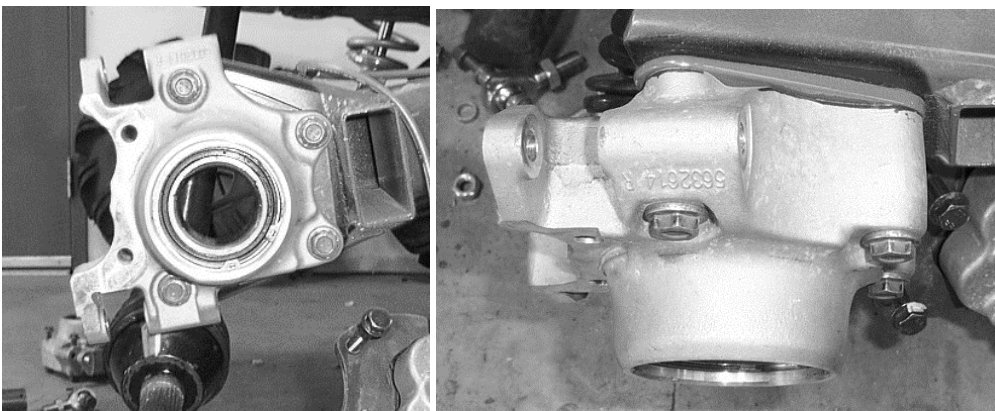
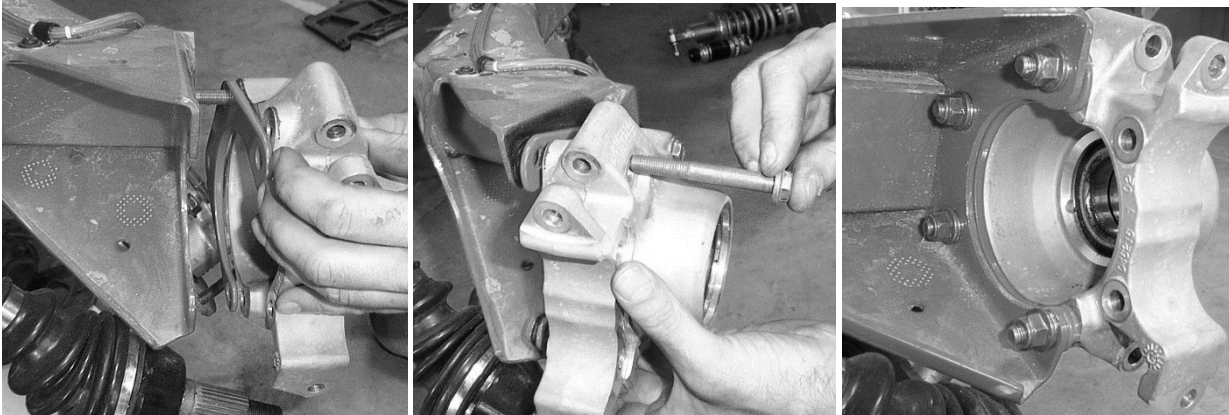
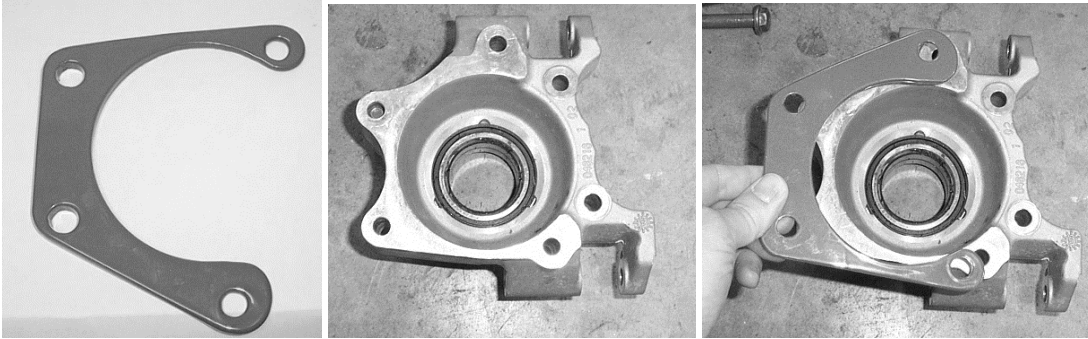

41. Insert the axle into the knuckle and hub assembly.

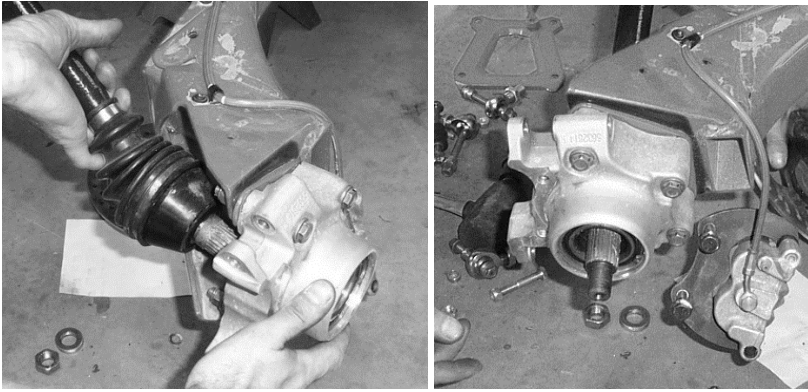

42. Included in the kit are new axle washers and a new crimp nut. You need to use two washers per axle. Fasten the axle to the hub assembly with the new crimp nut, using a punch to lock the axle nut in place.

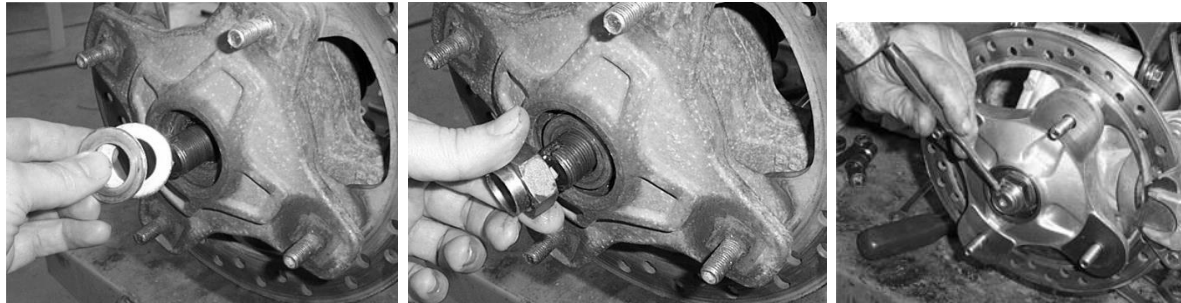

43. Connect the brake caliper before you connect the rear radius bars to the hub assembly. Attach the calipers using the factory hardware.

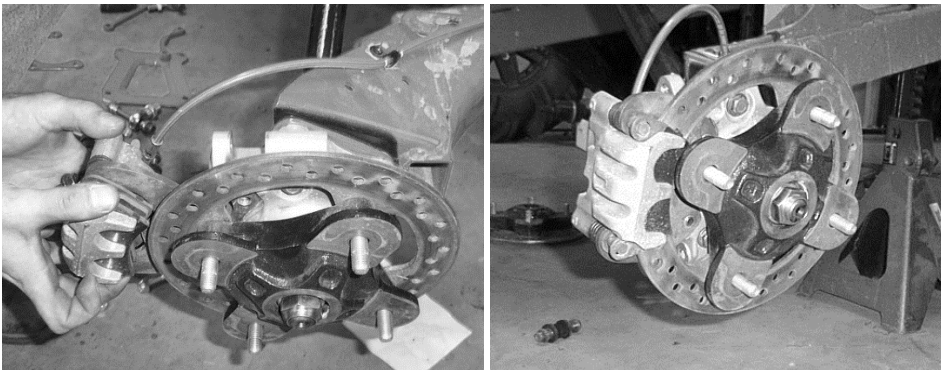

44. Next reattach the factory sway bar link to the trailing arms.

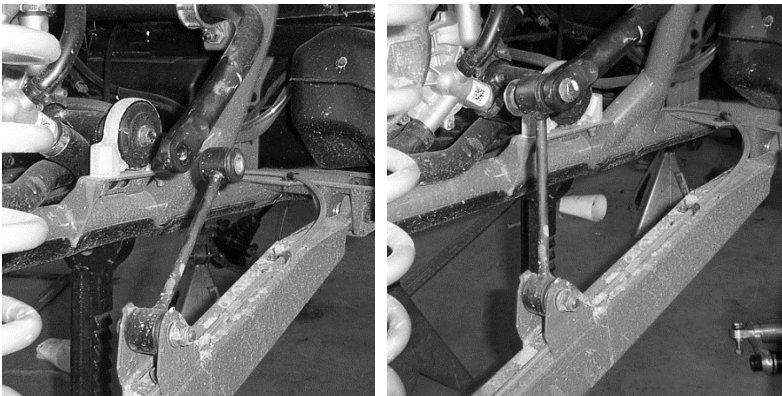

45. Attach the rear upper and lower radius bars to the knuckle assembly using the factory hardware.

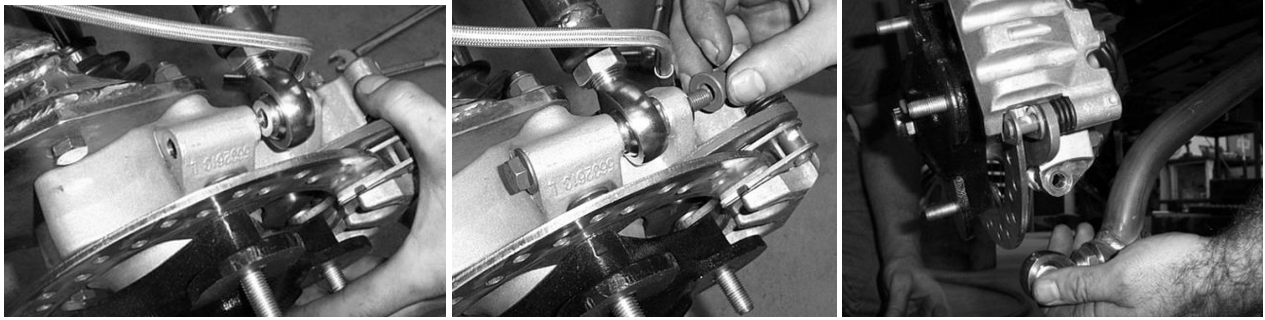

NOTE: There are LEFT and RIGHT Lower Radius Bars!! On the end of the lower bar where the heim joint connects will have a slight turn on it. When mounted on the RZR they need to be mounted with the turn pointing towards the front of the RZR.

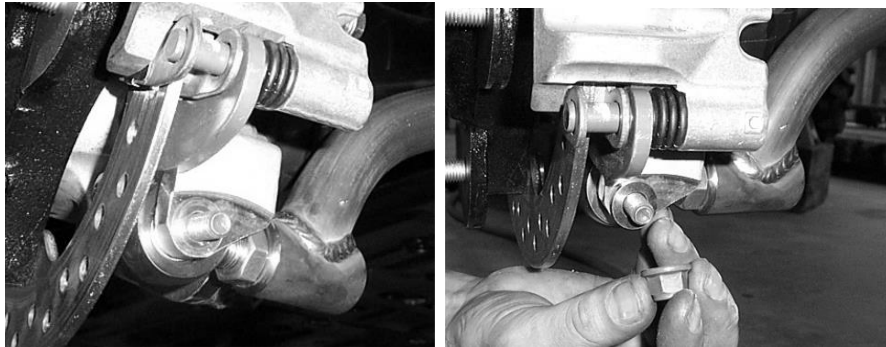

46. Repeat the steps for the opposite side.

47. Once you have completed both sides place the wheels back on the RZR and torque lugs to factory specifications.

SPECIAL INSTALLATION INSTRUCTIONS for HIGH LIFTER EDITION RZR 1000

1. On the rear left side of the RZR there is a snorkel hose that when the lift kit is installed comes in contact with the shock.
2. Using the large zip tie provided in the kit, pull the hose back away from the shock and secure it to the frame.

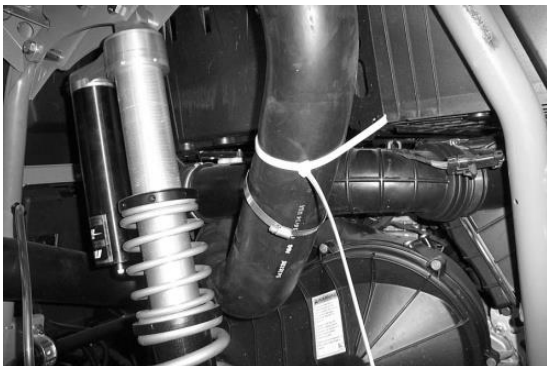

High Lifter Name Plate Installation

1. In the rear you will need to remove the plastic.



2. The arrows are pointing to the bolts that you will need to remove to all the plastic to be removed.

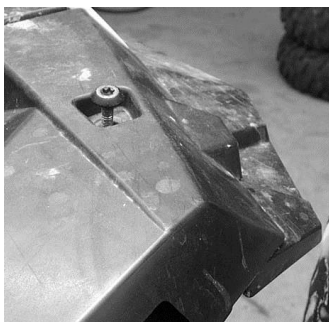
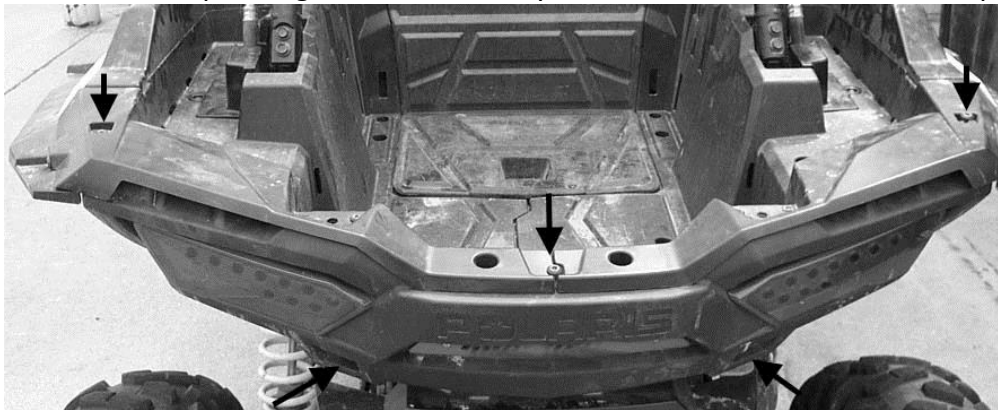

3. Place the High Lifter logo badge over the plastic honey comb opening. You will need to bend the plate to fit the contour of the plastic.

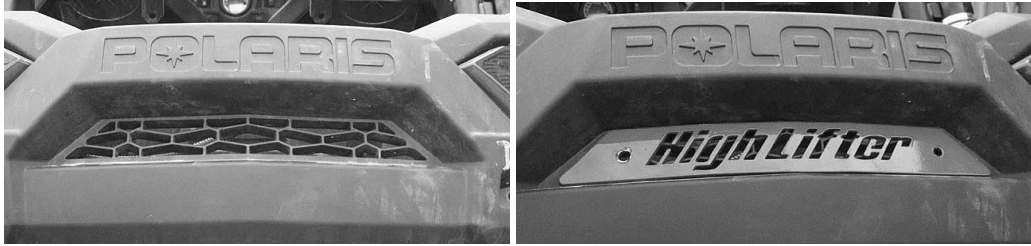

4. Using the two 5/16 x 1" button head bolts, 5/16" washers and 5/16" lock nuts connect the plate.

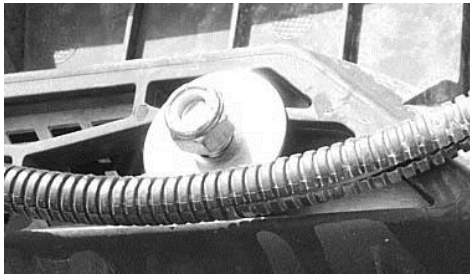

5. Place the plastic back on the RZR.



This product has a dual warranty. The suspension components have a life time warranty and the axles have a limited replacement. Please see information on the following pages.



High Lifter Lifetime Warranty

From the beginning, High Lifter has engineered and manufactured some of the toughest, most durable products on the market. That's why this product comes with a Lifetime Warranty. It's our promise that High Lifter will never let you down.

- The **Lifetime Warranty** covers products sold to the original purchaser only and is not transferable. The term of the warranty is for the lifetime of the vehicle in question.
- Normal wear and tear items and finishes, such as, but not limited to: Heim joints, tie rod ends, ball joints, bearings, seals, bushings, bushing sleeves, zinc plating , powder coating, or chipping and discoloration of any finish is not covered.
- High Lifter will ship the replacement product after the returned product has been inspected by High Lifter staff.
- The warranty shall not include claims for damages, installation time or labor charges, economic losses, inconvenience, transportation, towing, down time, direct or indirect or consequential damages or delay resulting from any defect.
- The warranty does not apply to products that have been improperly applied or improperly installed.

Making a warranty claim

1. All claims must be accompanied by the part and the original sales receipt or other acceptable proof of purchase from the original owner.
2. All warranties must be accompanied with a Return Merchandise Authorization (RMA) number. (Contact High Lifter at 318-524-2270 or 800-699-0947 for an RMA number)
3. When shipping the damaged product:
 - a. Write the RMA number on the outside of the box.
 - b. Also include the RMA number, proof of purchase and any notes inside the box.
 - c. Please keep your tracking number and shipment information.
4. The customer is responsible for shipping the product to High Lifter--return shipping within the lower 48 states will be paid by High Lifter products. With all warranty claims, only standard shipping services apply.
5. High Lifter will process your order within 24 business hours of receiving the returned item.
6. **Ship to:** High Lifter Products, 780 Professional Drive North, Shreveport, Louisiana 71105

For axle warranty see additional information sheet!

High Lifter Outlaw RCV Big Lift Axle Warranty Program

Thank you for purchasing a High Lifter Products Big Lift equipped with a set of Outlaw RCV Big Lift Axles. Our axles have been engineered to provide superior performance for use on your ATV/UTV.

LIMITED WARRANTY:

HIGH LIFTER PRODUCTS, INC. warrants to the **ORIGINAL** purchaser of any High Lifter Big Lift equipped with 4-Outlaw RCV Big Lift Axles for a total of one (1) axle warranty claim or breakage per set of 4 axles (not (1) warranty claim or breakage for each individual axle) for a period of one (1) year from the original date of purchase. This warranty covers defects in materials or workmanship or failures in normal services. Repair services will be available after the warranty has expired for an additional cost (repair costs will be determined by the actual components that need to be replaced). If you need repair service for your Outlaw RCV axle please contact your High Lifter representative at 1.800.699.0947 for an estimate.

The limited warranty is subject to the following conditions:

- a) The product is properly installed.
- b) **HIGH LIFTER** is not liable for any incidental or consequential damages to anything other than the axle covered by this warranty, including labor costs to remove/reinstall, loss of use of machine, damage to housings, or damage to OEM supplied parts.
- c) If the axle has been disassembled or modified by a third party, or has OEM parts installed on the axle, the warranty is null and void.
- d) Any axle damaged in a collision is excluded from this warranty. However, they may be refurbished for standard costs pending authorization by the owner.
- e) Warranty is non-transferable from the **ORIGINAL** purchaser.
- f) **HIGH LIFTER** reserves the right to inspect the axle and determine any defects in installation to determine the validity of a warranty's claim. This may include the **ORIGINAL** purchaser providing photographs of the ATV/UTV and its installed lift kit.
- g) Boots damaged by CV joint failures are covered under this warranty. Boots damaged by punctures or tears from trail obstructions are not covered under this warranty. Boot inspection should be a part of regular ATV/UTV maintenance.

REFUSED SHIPMENTS/ORDER CANCELLATION:

Refused shipments are subject to a 25% restocking fee plus return freight. If a customer wishes to cancel an order (provided it is not a special order product), it is the responsibility of the customer to cancel the order prior to the product being shipped. If a customer cancels an order after product has been shipped, the refused shipment, cancellation, or return will be subject to a 25% restocking fee and any freight charges incurred. For orders outside the United States, any fees associated with customs or duties are non-refundable.

DAMAGED SHIPMENTS:

All claims for damaged shipments must be made within 72 hours of delivery to the point of destination. Any damage to package should be noted with carrier at the time of delivery if possible. We will not be responsible for damage claims made over 72 hours after delivery to the point of destination.

OBTAINING A WARRANTY CLAIM:

All returns for warranty must be pre-approved by calling 1.800.699.0947. After warranty approval has been granted and a Return Merchandise Authorization (RMA) number issued, the axle must be received by HIGH LIFTER PRODUCTS within 15 calendar days. The RMA number must be clearly displayed on the return box or the return will be refused. An RMA number does not imply a replacement or refund on any product, but only that we will inspect the axle for warranty claims. For orders outside the United States, any fees associated with customs or duties are non-refundable. All claims must be accompanied by the sales receipt detailing date and place of purchase, a written explanation of the problem, a phone number, and e-mail address. A copy of this receipt must be included with the axle submitted for warranty repair or replacement. The purchaser is responsible for any freight charges on a warranty claim or repair service after the warranty expires, including incoming freight to High Lifter and return freight to the purchaser.